



SARADA VILAS COLLEGE

Krishnamurthypuram, Mysuru - 570 004

(Affiliated to the University of Mysore)

Reaccredited by NAAC with B+grade (CGPA : 2.70)

E-mail : principal@saradavilas.com, Website : www.saradavilas.com



Dr. M. Devika, M.Sc., M. Phil., Ph.D

Principal

Mobile : 9880024483

Table of Content

1.3 - Curriculum Enrichment

Data related to – 1.3.3

Number of students undertaking project work/field work/ internships

Sl. No	Content	Page No
1.	B.Sc. In Botany – Visit to Kukkarahalli Lake	1 - 4
2.	B.Sc. In Botany – Visit to Nandini Diary	5 - 13
3.	Department of Botany & Zoology - Visit to Kerala Malabar Botanical Garden	14 - 27
4.	Department of Zoology – Visit to Shuka Vana & Kishkinda Moolika Bonsai Garden	28 -30
5.	BMBT Students – Visit to Nandini Diary	31 - 34
6.	BMBT Students – Visit to Manipal School of Life School	35 – 42
7.	Department of Bio-Chemistry – Visit to Triphase Pharmaceuticals	43 - 70
8.	Students of B.Sc – Internship at CADD Technologies Pvt. Ltd	71 – 88
9.	Internship of B.Sc Hon.(DS & AI)	89 - 92
10.	Visit to R L Fine Chem Pvt Ltd – M.Sc Students	93 - 96
11.	Industrial Internship of M.Sc Students	97 - 111
12.	Field Visit to IIT Madras – M.Sc Students	112 -117
13.	Project work of M.Com Students	118 - 264

Dr. M. Devika

Principal

From,
Dr. Devika. M
Head, Department of Botany
Sarada Vilas College
Mysuru

04-08-2022

Mysore

To,
The Principal
Sarada Vilas College
Mysuru

Respected Madam,

Sub: Permission to take students for a visit to Kukkarahalli Lake

The University of Mysore has prescribed the second semester Botany students of B.Sc. B/Z and B/C course for a field trip to local areas to study the flora and update their knowledge in the field of Botanical science. Hence I request you to permit 26 students and two accompanying staff of our department to go for the visit on 06th August 2022.

Thanking you

yours sincerely

Dr. M Devika
M.Sc., M. Phil., Ph.D.
Principal
Sarada Vilas College,
Krishnamurthypuram, Mysuru

SARADA VILAS COLLEGE, MYSURU

DEPARTMENT OF BOTANY

List of Students (2021-22)

Place of Visit: Kukkarahalli Lake, Mysuru

II Semester

Sl. No	Reg. No.	Name
1	U01BG21S0008	DEVANAMPRIYA
2	U01BG21S0009	CHAITHRA K
3	U01BG21S0011	SRUJAN KUMAR M R
4	U01BG21S0015	NANDAN B N
5	U01BG21S0016	AKASH S
6	U01BG21S0033	SANJAY M
7	U01BG21S0038	SUDEEPNAYAK M
8	U01BG21S0041	ARJUN K
9	U01BG21S0047	HARSHA S
10	U01BG21S0054	SUDEEP H M
11	U01BG21S0055	DARSHAN R
12	U01BG21S0061	RAHUL N S
13	U01BG21S0065	SUDARSHAN H V
14	U01BG21S0069	LOHITH H C
15	U01BG21S0071	SUCHAN M N
16	U01BG21S0075	PRAVEEN R
17	U01BG21S0077	PRAJWAL S RAJ
18	U01BG21S0078	CHITHRA M
19	U01BG21S0079	PREETHAM S RAJ
20	U01BG21S0082	SUMANTH H V
21	U01BG21S0084	ASHWATH K A
22	U01BG21S0094	HANUMANTHA D
23	U01BG21S0095	PRASAD K S
24	U01BG21S0099	DEEKSHITHA M N
25	U01BG21S0101	RAVIKUMAR N
26	U01BG21S0105	SACHIN D S
27	U01BG21S0107	BINDU D S
28	U01BG21S0109	SANJANA B C
29	U01BG21S0110	VARUN N M

Principal
Sarada Vilas College
Mysore - 570 004

SARADA VILAS COLLEGE, MYSURU.

DEPARTMENT OF BOTANY

STUDY TOUR-2021-22

SECOND SEMESTER



A VISIT TO KUKKARAHALLI LAKE.

**PURPOSE OF VISIT: TO STUDY ALGA WHICH ARE CAUSING ALGAL BLOOMS
IN THE KUKKARAHALLI LAKE.**

DATE: 06-08-2022

Dr. M. Devika
M.Sc., M.Phil., Ph.D.
Principal
Sarada Vilas College,
Krishnamurthypuram, Mysuru

**SARADA VILAS COLLEGE,
KRISHNAMURTHYPURAM, MYSURU
DEPARTMENT OF BOTANY
REPORT ON VISIT TO KUKKARAHALLI LAKE TO STUDY ALGAL
BLOOMS**

A visit to Kukkarahalli Lake on 06th August 2022 was organized by the Department of Botany for II semester students to study algal blooms which is a part of their curriculum prescribed by the University of Mysore.

We visited the lake along with 28 students of II semester in the morning. We assembled near the entrance of the lake by 6'o clock in the morning and took a walk around the lake. The lake was sparsely covered by algal blooms due to heavy rainfall. We assisted the students in identifying algal blooms and explained them about harmful aspects of algal blooms. The lake water where the dense algal blooms were observed was collected for further observation in the laboratory which helps the students to know about the algal communities that are responsible for causing blooms.

Our visit to Kukkarahalli Lake was not only circumscribed to the study of algal blooms we also made observations on different hydrophytes growing in the lake, and different species of higher plants which made us to briefly study the vegetation of Kukkarahalli Lake. Students also collected some hydrophytes like *Pistia*, *Eichhornia*, *Azolla* from the lake to preserve them in the department museum.

Dr. M Devika
M.Sc., M.Phil., Ph.D.
Principal
Sarada Vilas College,
Krishnamurthypuram, Mysuru

From,

Dr. Devika. M
Head of the Department of Botany
Sarada Vilas College
Mysuru

To,

The Principal
Sarada Vilas College
Mysuru

Respected Madam,

Sub: "Permission for Nandini Diary visit"

With respect to the above cited subject, I request you to kindly permit the students of First year B.Sc. (BZ), to carry out the visit to the Nandini Milk Diary, in Hassan, as per the Botany syllabus requisite, under the guidelines of the University of Mysore. A total of 09 students will be part of the visit on 21/12/2022, accompanied by 01 Assistant Professor, The list of students and accompanying faculty is attached with this letter. Kindly oblige to our request.

Thanking you

Yours sincerely

Date: 15-12-2022
Place: Mysuru

15/12/2022



SARADA VILAS COLLEGE

Krishnamurthypuram, Mysore – 570 004 Karnataka

Affiliated to University of Mysore

Re accredited by NAAC with B+ grade (CGPA: 2.70)



Dr. Devika M, M.Sc., M. Phil., Ph. D
Principal
Mob: 9880024483

Date: 16.12.2022

To,

The General Manager,
Hassan Co-Operative Milk Producer's Societies Union Ltd,
HAMUL, Industrial Estate,
B. M. Road, Hassan-573201

Subject: "Permission for visit to Nandini Diary, Hassan"

Respected Sir/Madam,

With respect to the above cited subject, we would like to request you for permission to visit the HAMUL's Nandini Milk Diary at B.M. Road Hassan. This visit is to meet the syllabus guidelines of the University of Mysore for UG students of Fifth Semester Microbiology & First Semester Botany. They are expected to visit a Dairy industry for an exposure towards industrial processing and techniques. Consequently the students would like to visit your industry on Wednesday 21st December 2022.

A total of 50 students will be part of the visit, accompanied by 3 assistant professors. The list of students and accompanying faculty is attached with this letter. Kindly oblige to our request.

Thanking you,

Yours faithfully,

Principal
Sarada Vilas College
Mysore



Phone No: 0821-2332479, Fax:0821-2330221

E- mail: principal@saradavilas.com

website: www.saradavilas.com

SARADA VILAS COLLEGE
Krishnamurthy puram, Mysore – 570 004 Karnataka
Affiliated to University of Mysore
Re accredited by NAAC with B+ grade (CGPA: 2.70)



Dr. Devika M, M.Sc., M. Phil., Ph. D
Principal
Mob: 9880024483

Date: 19/12/2022

To,
The Manager,
Transport section KSRTC
Mysuru division, Mysuru.

Sub: Permission for hiring the bus.

With respect to the above cited subject, The Department of Microbiology and Botany of Sarada Vilas College is conducting a 1 day Academic visit to Nandini milk diary, Hassan Milk federation limited. Please provide a 54 seater bus for said visit on Wednesday 21/12/2022. I kindly Request you to provide student concession and oblige.

Route : Sarada Vilas College, Mysuru to Nandini Milk Diary, HAMUL, Hassan and back

Date of Travel : 21/12/2022

Time of Departure : 8 AM

Thanking you,

Place : Mysuru

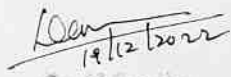
19/12/2022
Dr. Devika M
M.Sc., M. Phil., Ph.D.
Principal
Sarada Vilas College
Krishnamurthy Puram, Mysore - 570 004

I Semester B.Sc (BZ)
Nandini Dairy Visit 21.12.22

Sl. No	Roll. No	Name	Gender	Combination	Signature
1	22112	BHUVAN KUMAR V	M	BOT/ZOO	
2	22113	DARSHAN S GANESHEKAR	M	BOT/ZOO	<i>Darshan S</i>
3	22114	DARSHINI C	F	BOT/ZOO	<i>Darshini C.</i>
4	22116	MANDARA N	F	BOT/ZOO	<i>Mandara N</i>
5	22117	PRASHANTH C P	M	BOT/ZOO	<i>prashanth c.p</i>
6	22118	RAMYA C	F	BOT/ZOO	<i>Ramya c</i>
7	22119	RAVIKUMAR V	M	BOT/ZOO	<i>Ravi Kumar</i>
8	22120	SAGAR N M	M	BOT/ZOO	<i>Sagar N.M.</i>
9	22121	SHEIK ABRAR	M	BOT/ZOO	<i>Sheik ABRAR</i>

SARADAVILAS COLLEGE, MYSURU

DEPARTMENT OF BOTANY

STUDY TOUR 2022-23



A VISIT TO HASSAN MILK DAIRY

PURPOSE OF VISIT: TO STUDY APPLICATIONS OF MICROBES IN DAIRY INDUSTRY

DATE: 21ST DECEMBER 2022

Dr. M Devika
M.Sc., M.Phil., Ph.D.
Principal
Sarada Vilas College,
Krishnamurthypura

**SARADA VILAS COLLEGE,
KRISHNAMURTHYPURAM, MYSURU
DEPARTMENT OF BOTANY
REPORT ON VISIT TO HASSAN MILK DAIRY**

The Department of Botany had organised a visit to Hassan Milk dairy for first semester students of B.Sc. (B/Z) on 21st December 2022 as a part of their curriculum prescribed by the University of Mysore.

The purpose of the visit to Hassan Milk dairy was to know about the applications of microbes in dairy industry. Hassan dairy is a unit of Karnataka Milk Federation (KMF) which supplies milk and its products in and around Hassan districts. The milk produced in various dairy farms are collected and processed in this unit. The visit to Hassan Milk Dairy helped the students to know about the day to day applications of microorganisms and their role in conversion of milk into its respective dairy products. Hence the students gained the knowledge of utilization of microbes in dairy industry.

Dr. M. Devika
M.Sc., M.Phil., Ph.D.
Principal
Sarada Vilas College,
Krishnamurthypuram, Mysuru

SARADA VILAS COLLEGE

KRISHNAMURTHYPURAM, MYSURU

DEPARTMENT OF BOTANY

REPORT ON VISIT TO HASSAN MILK DAIRY

21.12.2022



SUBMITTED BY:

DARSHINI C

1st SEMESTER(BZ)

SARADA VILAS COLLEGE, MYSURU

SUBMITTED TO:

DEPARTMENT OF BOTANY

SARADA VILAS COLLEGE, MYSURU

ACKNOWLEDGEMENT

Under the prescribed syllabus of University of Mysore, we the students of Bachelor in Science of first semester were required to have a field visit programme to explore our knowledge in. It was Our practical great pleasure to visit The Dairy to understand role of Microbes in day-to-daylife,Hassan on 21st of December, 2022.

We would like to express our sincere gratitude to the **Department of Botany, Sarada Vilas College** for providing such a great opportunity to make ourselves familiar with the process involved in milk Dairy.

We would like to extend our gratitude to **Dr. M Devika**, Principal and Head of the Department, Botany, Sarada Vilas College for granting permission and for overall support. Our heartfelt thanks to **Capt. R A Manjunath** (Department of Microbiology & Biotechnology) **Mrs. Gagana S B** (Department of Botany), **Mr. Tribhuvan** (Department of Microbiology) for their support, interest and guidance during entire field visit with their suggestions and encouragement in this field report writing.

We are also thankful for **Mr. Pradeep**, Technical Officer, at Hassan Dairy, Hassan for his guidance.

SARADA VILAS COLLEGE

KRISHNAMURTHYPURAM, MYSURU

DEPARTMENT OF BOTANY

CERTIFICATE

This is to certify that **Mrs. Darshini.C** has participated in the Botany Field Study and has submitted field report as a partial fulfilment of I year B.Sc. 1st semester Botany practical examination prescribed by the University of Mysore for B.Sc. degree course during the year 2022-2023.



SIGNATURE OF THE

HEAD OF THE DEPARTMENT

Head of the Department of Botany
Sarada Vilas College
Mysore



SIGNATURE OF THE

BATCH IN-CHARGE

SIGNATURE OF THE EXAMINERS

Date: 19.01.2023

From,

Departments of Botany and Zoology
Sarada Vilas College,
Mysuru

Through,

The Principal
Sarada Vilas College
Mysuru

To,

Hon. Secretary
Sarada Vilas Educational Institution (R).
Mysuru,

Respected sir,

Sub: Seeking permission to take students of 5th semester for two days Kerala Malabar Botanical Garden Visit.

It is a part of curriculum and mandatory that, 5th B.Sc. CBZ students should be taken for field study to update their knowledge in field of Botanical and Zoological Science and specimen collection. Students are supposed to submit a report on the visit for which University has allotted 10 marks each in Botany and Zoology. Hence we request you to permit 34 students of 5th semester CBZ and staff members of Dept. of Botany and Zoology to accompany the students on 20th and 21st of January 2023. It would be appreciated if we could be granted permission.

Thanking you

Received
After
19/1/2023

Yours sincerely



Principal
Sarada Vilas College
Mysuru - 570 004

[SPECIAL PERMIT]

TRANSPORT DEPARTMENT, KARNATAKA

MYSURU WEST RTO

SPECIAL PERMIT



1. Permit Number **KA2023-SPL-0720A**
2. Name of The Permit Holder **MANAGING DIRECTOR**
3. Father's/Husband's Name (In Individual Case) **NA**
4. Address **KSRTC BANGALORE MYSORE RURAL DIVISION
MYSORE, Karnataka Mysore-570015**
5.
 - a). Type of Vehicle **Bus**
 - b). Registration Mark **KA09F5488**
 - c). Chassis Number **MB1PBED3LEKF0874**
 - d). UnLaden Weight **4947**
 - e). Seating Capacity **41**
 - f). Sleeper Capacity **0**
 - g). Laden Weight **16200**
 - h). Make/Model **ASHOK LEYLAND LTD/VK1611.0D4R**
 - i). Engine Number **LKEZ400498**
 - j). Tax Valid Upto **01-MAR-2024**
 - k). Insurance Valid Upto **01-MAR-2024**
 - l). Fitness Valid Upto **01-MAR-2024**
6. Purpose of Journey(s) **TOUR**
7.
 - a). Route or Area for which Temporary permit is valid **From: MYSORE To: SULTHAN BATHERY AND BACK
CALICUT-SULTHAN BATHERY-WAYNADU WILD LIFE
SENTURY-EDAKKAL CAVES-SUCHIPARA WATER
FALLS-MEENMUTTY WATER FALLS**
 - b). -Via
8. Date of expiry **From: 20-Jan-2023 To: 21-Jan-2023**
9. Nature of goods if to be carried **PASSENGER LUGGAGE**



Certified That in respect of the Vehicle mentioned above, all taxes, and fees payable in this State up to the date of expiry of this permit have been paid.

[This Permit holder shall pay the tax due to other states, if any, as per the rates specified by each state to the nearest taxation authority of that states, if the tax of other state is not already paid. The Permit shall be produced on demand by the Police Officer in Uniform.]

[The holder of the permit shall maintain trip sheets in such form as the Regional Transport Authority may be general or special order, direct and shall carry them in the vehicle.]

Date: 19-Jan-2023

Secretary
Deputy Secretary/Asstt. Secretary
And State Regional Transport Authority
MYSURU WEST RTO, Karnataka

SARADA VILAS COLLEGE, MYSURU
DEPARTMENT OF BOTANY AND ZOOLOGY
FIELD VISIT 20TH AND 21ST JANUARY 2023

STUDENT LIST

Sl.No.	N.ROLL	Reg. No.	Name	SIGNATURE
1	20167	M2000714	ANKITHA H S	Ankitha H.S.
2	20168	M2000721	B GAYATHRI AJITH	Gayathri Ajith
3	20170	M2000728	BHAVANA S B	Bhavana S.B.
4	20171	M2000734	CHAITHRA M U	Chaithra M.U.
5	20172	M2000736	CHANDHAN J	Chandhan J.
6	20174	M2000740	CHANDRA V	Chandra V.
7	20175	M2000742	CHARAN SHETTY J	Charan
8	20176	M2000754	DIVYA Y S	Divya Y.S.
9	20180	M2000763	HARSHITHA N D	Harshitha N.D.
10	20181	M2000767	HEMPRASAD B C	Hempasad B.C.
11	20182	M2000769	JAINKAR M	Jainkar M.
12	20183	M2000776	KEERTHISHREE U	Keerthishree U.
13	20187	M2000797	MANIKANTA B	Manikanta B.
14	20189	M2000804	MANOJ M T	Manoj M.T.
15	20191	M2000810	MEGHANA N	Meghana N.
16	20192	M2000812	MYNAKUMARI A P	Mynakumari A.P.
17	20193	M2000816	NANDHAN H B	Nandhan H.B.
18	20194	M2000823	NISHANTH KUMAR N S	Nishanth Kumar N.S.
19	20195	M2000828	PAVAN M S	Pavan M.S.
20	20196	M2000829	PAVAN P	Pavan P.
21	20197	M2000830	PRAJVALA Pragyaal A	Prajvala Pragyaal A.
22	20200	M2000836	PRAVEEN KUMAR S	Praveen Kumar S.
23	20205	M2000865	SANDHEEP R	Sandheep R.
24	20219	M2000866	SANJAY H S	Sanjay H.S.
25	20206	M2000868	SEVANTHI MAYURI A	Sevanti Mayuri A.
26	20208	M2000878	SHIVAKUMARA M	Shivakumara M.
27	20210	M2000888	SOWRAV M S	Sowrav M.S.
28	20212	M2000899	SUPRITHA R	Supritha R.
29	20177	M2000906	G K TEJUKUMAR	G.K. Tejukumar
30	20214	M2000910	VARUN J	Varun J.
31	20215	M2000912	VIKAS PS	Vikas P.S.
32	20216	M2000916	VISMITHA M C	Vismitha M.C.
33	20218	M2000922	YOGESH N D	Yogesh N.D.
34			AKASH A N	Akash A.N.

FACULTY LIST

Sl. No	Name	Department	Signature
1	Mrs. Shakunthala	Zoology	
2	Mr. Likith Clement	Biochemistry	Likith
3	Mrs. Gagana S B	Botany	G.S.B.
4	Mr. Yashwanth V M	Botany	Yashwanth V.M.
5	Ms. Spoorthy S	Zoology	

 Principal
 Sarada Vilas College
 Mysuru - 570 004

SARADAVILAS COLLEGE , MYSURU

DEPARTMENT OF BOTANY

STUDY TOUR 2022-23



A VISIT TO MALABAR BOTANICAL GARDEN, KERALA

PURPOSE OF VISIT: TO STUDY FLORA AND COLLECTION RARE PLANT SPECIMENS

DATE: 21ST & 22ND JANUARY 2023

Dr. M. Devika
M.Sc., M.Phil., Ph.D.
Principal
Sarada Vitas College,
Mishra Murthy Puram, Mysuru.

**SARADA VILAS COLLEGE,
KRISHNAMURTHYPURAM, MYSURU
DEPARTMENT OF BOTANY
REPORT ON VISIT MALABAR BOTANICAL GARDEN**

The Department of Botany had organised a field visit to Malabar botanical garden, Kozhikode, Kerala for V semester students as a part their curriculum prescribed in the syllabus by the University of Mysore. The objective of the visit was to study flora and to collect plant species for the purpose of preserving them using the herbarium technique. The trip was organised for two days that is on 20th and 21st of January 2023. The first day of the visit was to Malabar botanical garden which is in the Kozhikode of Kerala state. Malabar botanical garden is spread over 45 acres which consists of different sections comprising different plant communities. Students observed different plant species and gained the knowledge of plants growing in different habitats.

Dr. M. Devika
M.Sc., Ph.D.
Principal
Sarada Vilas College,
Krishnamurthipuram, Mysuru

SARADA VILAS COLLEGE
KRISHNAMURTHYPURAM, MYSURU-4



REPORT ON VISIT TO MALABAR BOTANICAL GARDEN, KERALA.

III B.Sc-CBZ [5th Sem]STUDENTS, SARADA VILAS COLLEGE, MYSURU



Heliconia latispatha

SUBMITTED TO;

**Department of Botany
Sarada Vilas College, Mysuru**

SUBMITTED BY;

SANJAY · H · S ·

III B.Sc-CBZ [5TH Sem]

Reg No: M2000866

SARADA VILAS COLLEGE

KRISHNAMURTHYPURAM, MYSURU-4

DEPARTMENT OF BOTANY

CERTIFICATE

This is to certify that Mr/Ms. **SANJAY H.S.** has participated in the Botany field study and submitted field report as a practical fulfillment of III year B.Sc., V semester Botany Practical Examination prescribed by The University of Mysore for B.Sc. degree course during the year 2022-2023.

Signature of Batch-in-charge

Signature of Head of the
Head of the Department of Botany
Sarada Vilas College
Department
Mysore

YEAR OF Kean Natalia 28/2/23
VALUED 28/02/23
1.
2.

Date: 19.01.2023

From,
Departments of Botany and Zoology
Sarada Vilas College,
Mysuru

To,
The Principal
Sarada Vilas College
Mysuru

Respected sir,

Sub: Seeking permission to take students of 5th semester for Two days study tour to visit Malabar Botanical Garden and Wayanad Wild Life Sanctuary, Kerala.

It is a part of curriculum and mandatory that, 5th B.Sc. CBZ students should be taken for field study to update their knowledge in field of Botanical and Zoological Science and specimen collection. Students are supposed to submit a report on the visit for which University has allotted 10 marks each in Botany and Zoology. Hence we request you to permit 34 students of 5th semester CBZ and staff members of Dept. of Botany and Zoology to accompany the students on 20th and 21st of January 2023. It would be appreciated if we could be granted permission.

Thanking you

Yours sincerely

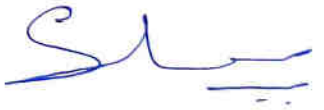
(Shakunthala)

19/1/2023
Dr. M. Devika
M.Sc., M.Phil., Ph.D.
Principal
Sarada Vilas College,
Kristnamurthypuram, Mysuru.

Date: 19.01.2023

From,

Departments of Botany and Zoology
Sarada Vilas College,
Mysuru

Through,

The Principal
Sarada Vilas College
Mysuru

To,

Hon. Secretary
Sarada Vilas Educational Institution (R).
Mysuru,

Respected sir,

Sub: Seeking permission to take students of 5th semester for two days Kerala Malabar Botanical Garden Visit.



It is a part of curriculum and mandatory that, 5th B.Sc. CBZ students should be taken for field study to update their knowledge in field of Botanical and Zoological Science and specimen collection. Students are supposed to submit a report on the visit for which University has allotted 10 marks each in Botany and Zoology. Hence we request you to permit 34 students of 5th semester CBZ and staff members of Dept. of Botany and Zoology to accompany the students on 20th and 21st of January 2023. It would be appreciated if we could be granted permission.

Thanking you

Permitted

Yours sincerely



1399 19/1/2023



SARADA VILAS COLLEGE, MYSURU
DEPARTMENT OF ZOOLOGY

Field visit to Wayanad Wildlife Sanctuary and Malabar Botanical Garden, Kerala
20/01/2023 to 21/01/2023

SL. No	REG. NO	NAME	SIGNATURE
1	M2000711	Amith Raj G B	Amithraj G.B
2	M2000714	Ankitha H S	Ankitha H.S.
3	M2000721	B Gayathri Ajith	Gayathri Ajith
4	M2000728	Bhavana S B	Bhavana S.B
5	M2000734	Chaitra M U	Chaitra M.U
6	M2000736	Chandan J	Chandan J
7	M2000740	Chandra V	Chandran
8	M2000742	Charan Shetty J	Charan Shetty J
9	M2000754	DIVYA Y S	Divya Y.S.
10	M2000906	G K Tejukumar	G.K. Tejukumar
11	M2000763	Harshitha N D	Harshitha N.D
12	M2000767	Hemprasad B C	Hemprasad B.C
13	M2000769	Jainkar M	Jainkar M
14	M2000776	Keerthishree U	Keerthishree U.
15	M2000787	Lohith Beerappa Heggade V S	Lohith Beerappa Heggade V.S
16	M2000795	Mahesha M N	Mahesha M.N
17	M2000797	Manikanta B	Manikanta B
18	M2000804	Manoj M. T	Manoj M.T
19	M2000810	Meghana N	Meghana N.
20	M2000812	Mynakumari A P	Mynakumari A.P
21	M2000816	Nandan H B	Nandan H.B
22	M2000823	Nishanthkumar N S	Nishanthkumar N.S
23	M2000828	Pavan M S	Pavan M.S.
24	M2000829	Pavan P	Pavan P
25	M2000830	Prajwal A	Prajwal A
26	M2000831	Prajwal G	Prajwal G
27	M2000832	Prajwal M S	Prajwal M.S
28	M2000836	Praveen Kumar S	Praveen Kumar S
29	M2000842	Rajesh S N	Rajesh S.N
30	M2000865	Sandheep R	Sandheep R.
31	M2000868	Sevanthi Mayuri A	Sevanthi Mayuri A
32	M2000878	Shivakumara M	Shivakumara M
33	M2000880	Shivu R	Shivu R
34	M2000888	Sowrav M S	Sowrav M.S
35	M2000899	Supritha R	Supritha R
36	M2000910	Varun J	Varun J
37	M2000912	Vikas P S	Vikas P.S
38	M2000916	Vismitha M C	Vismitha M.C
39	M2000917	Yashawanth G R	Yashawanth G.R
40	M2000922	Yogesh N D	Yogesh N.D
41	M2000866	Sanjay H S	Sanjay H.S
42	MT802358	Akash A N	Akash A.N

Head of the Dept. of Zoology
Sarada Vilas College
MYSORE

FIELD VISIT TO MALABAR BOTANICAL GARDEN AND WAYANAD WILDLIFE SANCTURTY, KERALA



6RRH+23V, Poovangal, Kozhikode, Kerala 673014, India

Latitude

11.23976372°

Longitude

75.82776269°

Local 02:31:28 PM

GMT 09:01:28 AM

Altitude -82.98 meters

Friday, 20-01-2023



M9C9+PJP, Muthanga, Kerala 673592, India

Latitude

11.6717026°

Longitude

76.36867436°

Local 09:24:21 AM

GMT 03:54:21 AM

Altitude 767.1 meters

Saturday, 21-01-2023



6RRH+23V, Poovangal, Kozhikode, Kerala 673014, India

Latitude
11.23973019°

Longitude
75.82751064°

Local 02:35:33 PM
GMT 09:05:33 AM

Altitude -85.4 meters
Friday, 20-01-2023



SARADA VILAS COLLEGE

KRISHNAMURTHYPURAM, MYSURU

DEPARTMENT OF ZOOLOGY **FIELD VISIT REPORT**



Wayanad Wild Life Sanctuary



BACHELOR OF SCIENCE
FIFTH SEMESTER 2022-23

20th and 21st January, 2023

Wayanad, Kerala

SARADA VILAS COLLEGE

MYSURU

DEPARTMENT OF ZOOLOGY

CERTIFICATE

VALUED
1. 
2. 
EXAMINERS

This is to certify that Ms./Mr....PAVAN . M.S..... has participated in the Zoology field visit and submitted field report as the Practical fulfillment of 3rd year, 5th semester Zoology Practical Examination prescribed by the University of Mysore for B.Sc. CBZ course during the Year 2022-2023.

Signature of Batch incharge

Signature of Head of the Department
Head of the Dept. of Zoology
Sarada Vilas College
MYSORE

From,
Shakunthala
Assistant Professor and Head
Department of Zoology
Sarada vilas college
Mysuru

To,
The Principal
Sarada Vilas College
Mysuru

Respected madam,

Sub: Seeking permission to take Ist and IIIrd Semester BZ students to Shuka Vana and Kishkindha moolika bonsai garden, Mysuru on 5th January 2023.

As a part of National Bird Day celebration, The Zoology Department has planned a visit to Shuka Vana, a rehabilitation center for birds. This visit would create awareness about bird conservation in students. So, I request you to permit all the first and third semester BZ students accompanied by me and one teaching faculty of the Department to visit Shuka Vana and Kishkindha moolika bonsai garden, Mysuru on 5th January (Thursday) 2023 at 2.00pm. It would be a great learning experience.

Thanking you.

Date – 04/01/2023
Place - Mysuru

Your's sincerely

Head of the Dept of Zoology
Sarada Vilas College,
MYSURU

permitted

Dr. H. Devika
M.Sc., M.Phil., Ph.D.
Principal
Sarada Vilas College,
Krishnamurthypuram, Mysuru



SARADA VILAS EDUCATIONAL INSTITUTIONS(R)

SARADA VILAS COLLEGE

Krishnamurthypuram, Mysore – 570 004 Karnataka.

Affiliated to University of Mysore

Re accredited by NAAC with A grade (CGPA: 3.19)



FIELD VISIT TO SHUKA VANA, MYSURU

On 5th January 2023, The Department of Zoology organized a field visit to Shuka Vana, Sri Ganapathy Sachchidananda Ashrama, Mysuru on the occasion of National Bird Day.

All the students of CBZ and BZ along with Zoology and Botany department faculties departed from the college and reached the destination. As Shuka Vana is a parrot park, a rehabilitation center for birds, we could witness numerous indigenous as well as exotic birds from Indonesia, Malaysia, and Singapore. We also learnt that the Shuka Vana has made it to the 'Guinness World Records' for housing the largest number of bird species in an aviary. It has more than 450 species of parrots totaling over 2200 birds. Appreciating the morphology and pigmentation of birds we could also learn about its behavior, food habits and IUCN status.

Next, we visited "Kishkindha Moolika Bonsai Garden", which is located near Shuka Vana. The Garden consists of very valuable bonsai trees ranging in age from 1 year to 200 years collected from various countries around the world such as China, Indonesia, Malaysia, America, West Indies, Singapore etc.

We also visited 'Vishwam Museum' situated in the Ashrama and were able to see an eclectic collection of objects such as musical instruments, minerals, gemstones, crystals, carpets, paintings, coins and stamps, etc. We departed to our homes by 6.00PM.

FIELD VISIT TO SHUKHA VANA AND BONSAI GARDEN, MYSURU



7MP5+266, Gundurao Nagar, Chamundipuram, Mysuru, Karnataka
570025, India

Latitude

12.28514125°

Longitude

76.65811845°

Local 05:08:03 PM

GMT 11:38:03 AM

Altitude 574.4 meters

Thursday, 05-01-2023



7MM5+H72, Gundurao Nagar, Datta nagar, Mysuru,
Karnataka 570025, India

Latitude

12.28397958°

Longitude

76.65827593°

Local 04:55:01 PM

GMT 11:25:01 AM

Altitude 581.36 meters

Thursday, 05-01-2023



SARADA VILAS COLLEGE

Krishnamurthypuram, Mysore – 570 004 Karnataka

Affiliated to University of Mysore

Re accredited by NAAC with B+ grade (CGPA: 2.70)



Date: 22/12/2022

Dr. Devika M, M.Sc., M. Phil., Ph. D

Principal

Mob: 9880024483

TOUR VISIT REPORT

“HAMUL’s Nandini Milk Diary, B.M. Road Hassan” on 21st December 2022.

The Department of Microbiology of Sarada Vilas College organised an institutional visit to the “HAMUL’s Nandini Milk Diary”, at B.M. Road, Hassan, **on 21st December 2022** for the **UG-Final year, Fifth semester, BMBt (B.Sc.) Students** as part of the UOM syllabus (CBCS) requisite.

A total of 39 students were part of the visit along with 3 faculty members. Upon arrival, the students were greeted by Mr. Ravi, QCA, who explained and showed the process of milk procurement and quality assurance testing. He also explained of the Diary infrastructure and the wide variety of products produces at the facility. Later Ms. Roopa, from packaging department conducted the students through the packaging process and facilities explaining the different types of milk packaged. Finally Dr. Nataraju, Manager, Quality control, explained to the students of the different parameters used in qualitative and quantitative evaluation for purity of milk and its products.

Dr. M. Devika
M.Sc., M.Phil., Ph.D.
Principal
Sarada Vilas College,
Krishnamurthypuram, Mysore

Tour Visit

HAMUL's Nandini Milk Dairy, B.M. Road Hassan" on 21st December 2022



Handwritten signature and text:
Dr. H. S. Gowda
Principal
Kannada University
Kannada University, Hampi

List of accompanying faculty			Signature
Sl. No.	Faculty Name	Designation	
1	Capt. R. A. Manjunath	Assistant Professor, Head of the Department	
2	Mrs. S. B. Gagana	Assistant Professor	
3	Mr. Tribhuvan K. R.	Assistant Professor	

List of students				
Sl. No.	Name	Combination	Register No.	Signature
1	BHARATH P	BMBt	M2000725	
2	BHARATHKUMAR M V	BMBt	M2000726	
3	BHUMIKA D	BMBt	M2000730	
4	CHANDAN K R	BMBt	M2000737	
5	CHEZHAN NAIK B O	BMBt	M2000743	
6	CHIRAG M L	BMBt	M2000745	
7	D S SHARATH	BMBt	M2000747	
8	DARSHAN GOWDA T M	BMBt	M2000748	
9	GAGANDEEP S M	BMBt	M2000756	
10	HARISHNAYAK T	BMBt	M2000760	
11	KIRAN N V	BMBt	M2000779	
12	KITTY V K	BMBt	M2000780	
13	KUMARASWAMY A C	BMBt	M2000782	
14	MADHU S R	BMBt	M2000791	
15	MAHESHPRASAD R	BMBt	M2000796	
16	MANOJ K	BMBt	M2000800	
17	MANOJ R	BMBt	M2000806	
18	MONISH KUMAR	BMBt	M2000811	
19	NAGACHANDRA G B	BMBt	M2000813	
20	NAGAHARSHA KARANTH K P	BMBt	M2000814	
21	NAVANEETH P K	BMBt	M2000818	
22	NAYANA S	BMBt	M2000822	
23	PUNEETH KUMAR N	BMBt	M2000839	
24	RAKESH S	BMBt	M2000843	
25	RAKSHITHA H K	BMBt	M2000846	
26	RAVICHANDRA KUMAR N	BMBt	M2000853	
27	ROHITH M SHETTY	BMBt	M2000857	
28	SADHANA G A	BMBt	M2000862	
29	SHAMANTH C M	BMBt	M2000869	
30	SHANTHARAJU Y K	BMBt	M2000870	
31	SHIVARAJU S	BMBt	M2000879	
32	SIDDIQ PASHA	BMBt	M2000884	
33	SUDEEP B	BMBt	M2000892	
34	SUDEEP N	BMBt	M2000894	
35	SUDEEP S	BMBt	M2000895	
36	TEJASWINI N	BMBt	M2000905	
37	THILAK R	BMBt	M2000908	
38	VENKATESHA T	BMBt	M2000911	
39	YASHWANTH L	BMBt	M2000920	

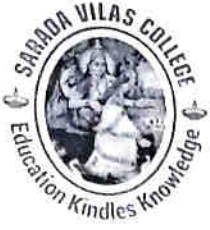

SARADA VILAS COLLEGE

Krishnamurthypuram, Mysore – 570 004 Karnataka

Affiliated to University of Mysore

Re accredited by NAAC with B+ grade (CGPA: 2.70)



Dr. Devika M, M.Sc., M. Phil., Ph. D
Principal
Mob: 9880024483

Date: 16.12.2022

To,

The General Manager,
Hassan Co-Operative Milk Producer's Societies Union Ltd,
HAMUL, Industrial Estate,
B. M. Road, Hassan-573201

Subject: "Permission for visit to Nandini Diary, Hassan"

Respected Sir/Madam,

With respect to the above cited subject, we would like to request you for permission to visit the HAMUL's Nandini Milk Diary at B.M. Road Hassan. This visit is to meet the syllabus guidelines of the University of Mysore for UG students of Fifth Semester Microbiology & First Semester Botany. They are expected to visit a Dairy industry for an exposure towards industrial processing and techniques. Consequently the students would like to visit your industry on Wednesday 21st December 2022.

A total of 50 students will be part of the visit, accompanied by 3 assistant professors. The list of students and accompanying faculty is attached with this letter. Kindly oblige to our request.

Thanking you,

Yours faithfully,



SARADA VILAS COLLEGE

Krishnamurthypuram, Mysore – 570 004 Karnataka

Affiliated to University of Mysore

Re accredited by NAAC with B+ grade (CGPA: 2.70)



Date: 20/06/2023

Dr. Devika M, M.Sc., M. Phil., Ph. D

Principal

Mob: 9880024483

TOUR VISIT REPORT

“Manipal School of Life Sciences” (MSLS) on 16th & 17th June 2023

The Department of Biotechnology & Microbiology of Sarada Vilas College organised an institutional visit to the ***“Manipal school of Life Sciences (MSLS)”***, Manipal Acedeny of Higher Education, Manipal, Udupi-576104 ***on 16th & 17th June 2023*** for the ***UG-Final year, BMBT (B.Sc.) Students*** as part of the UOM syllabus (CBCS) requisite.

A total of 38 students were part of the visit along with 3 faculty members. Upon arrival, the students were greeted and addressed by Dr. K. P. Guruprasad, Associate Director, (MSLS) and the research scholars.

The students were taken through the different facilities of the institution such as the Green-house, Biophysics lab, Microbiology lab, Ageing lab, Radiology lab, Plant tissue culture lab, Drosophila lab and Animal tissue culture lab. The students witnessed the instruments used at different facilities and were thought about the research programs being carried out.

They also explored the Manipal Museum of Anatomy & Pathology (MAP) where numerous formalin-fixed specimens related to the human body and pathological conditions of various organs are housed, along with studs and skeletal specimens of both human and animal origins. The students also visited the experience theatre & planetarium where they learned about more about the Manipal institute and the solar system respectively.

Head of the Department
Department of Microbiology
Saradavilas College, Mysore

Dr. M. Devika
M.Sc., M.Phil., Ph.D.
Principal
Sarada Vilas College,
Krishnamurthypuram, Mysore

Tour Visit

“Manipal School of Life Sciences (MSLS), Manipal, Udupi - 576104”

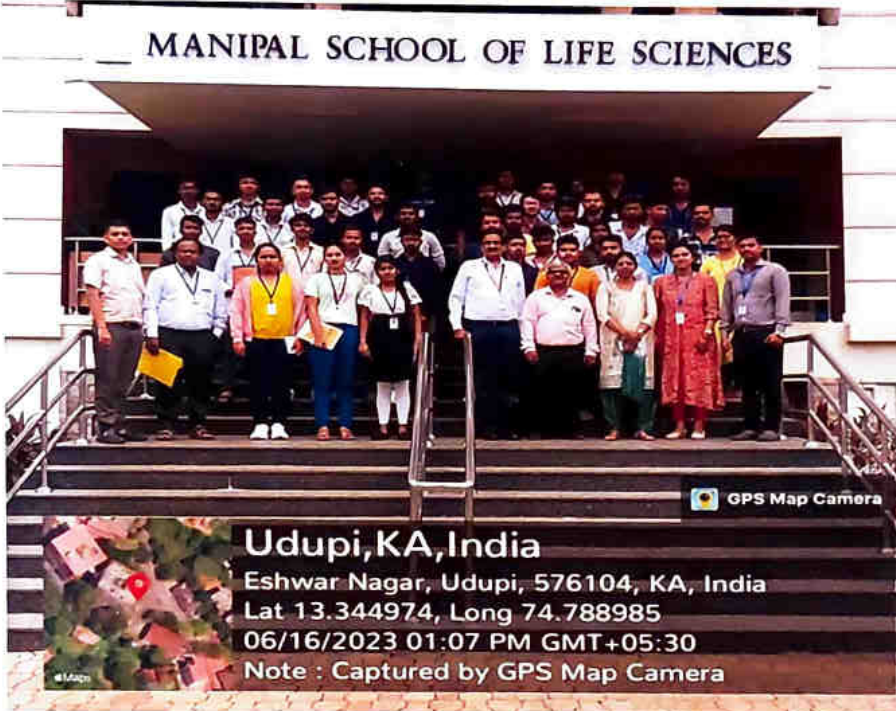

“MSLS – Green House”



Tour Visit - MSLS

HPLC-TOF Room

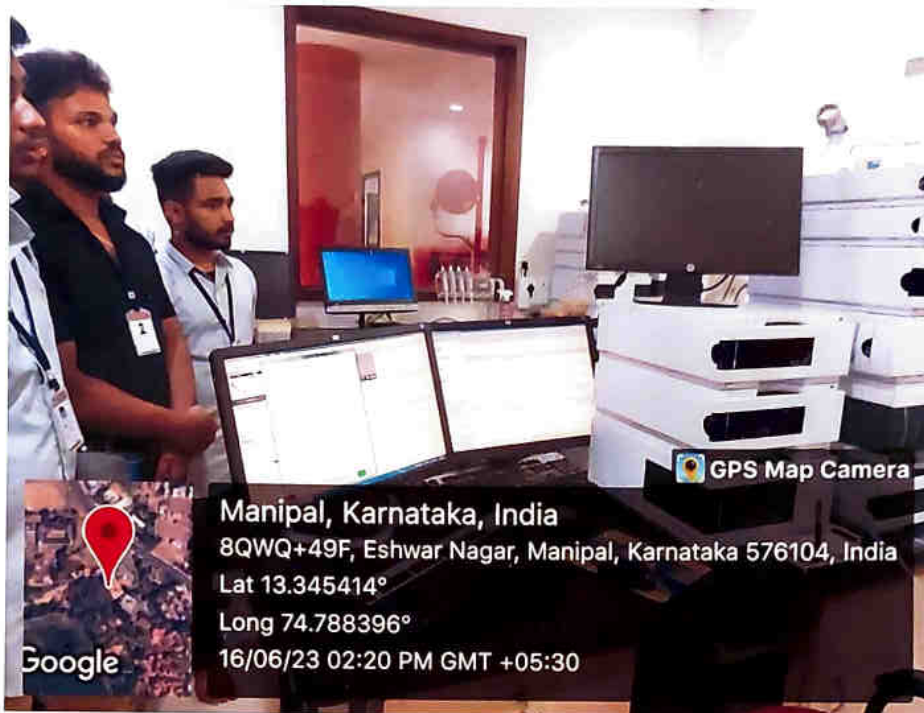

Manipal, Karnataka, India
 8QWQ+49F, Eshwar Nagar, Manipal, Karnataka 576104, India
 Lat 13.345414°
 Long 74.788396°
 16/06/23 02:20 PM GMT +05:30

GPS Map Camera

Manipal Museum of Anatomy & Pathology (MAP)



Manipal, Karnataka, India
 9Q2P+V5Q, Madhav Nagar, Eshwar Nagar, Manipal, Karnataka 576104, India
 Lat 13.352652°
 Long 74.785517°
 16/06/23 05:26 PM GMT +05:30

GPS Map Camera

pen
Principal

Sarada Vilas College
 Mysore - 570 004

Tour Visit - MSLS

"Manipal Academy Higher Education (MAHE)" - Experience Theatre



Principat
 Sarada Vilas College
 Mysore - 570 004

Phone : 0821 - 2332479

Fax : 0821 - 2330221

Sarada Vilas Educational Institutions (R)



SARADA VILAS COLLEGE

Krishnamurthypuram, Mysuru - 570 004

(Affiliated to the University of Mysore)

Reaccredited by NAAC with B+grade (CGPA : 2.70)

E-mail : principal@saradavilas.com, Website : www.saradavilas.com



Dr. M. Devika, M.Sc., M. Phil., Ph.D

Principal

Mobile : 9880024483

Date: 02/06/2023

To,

The Director,

Manipal School of Life Sciences College (MLSC),

Manipal - 576104.

Respected Sir/madam,

Sub: Request permission to visit School of Life Sciences College, Manipal.

With respect to the above cited subject, we would like to request you for permission to visit the School of life sciences, planetarium and experience theatre at Manipal Academy of Higher Education. This visit is to meet the syllabus guidelines of the University of Mysore for B.Sc. (UG) students of Sixth Semester BMBt. Syllabus prescribes visit to industries/Institutions for an exposure to recent trends and applications in life science. Consequently the students would like to visit your institution on **Friday 16th June 2023 forenoon.**

A total of 40 students will be part of the visit, accompanied by 3 Assistant Professors. The list of students and accompanying faculty is attached with this letter. Kindly oblige to our request.

Thanking you,

Place: Mysuru

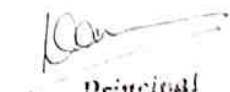

Yours faithfully,

Principal
Sarada Vilas College
Mysore - 570 004





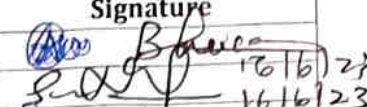
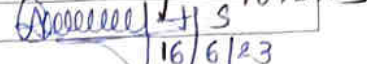





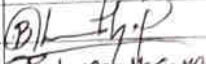
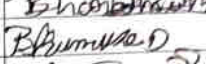

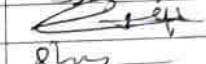

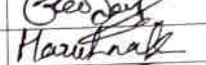
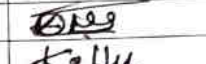
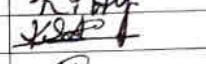
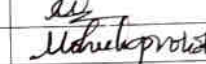
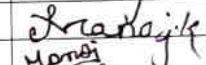

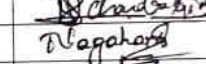
Saradavilas college Mysore,
Trip on 16.6.2023 to 17.6.2023

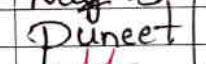
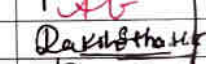
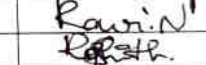
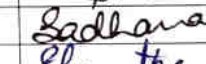
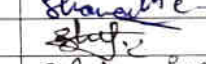
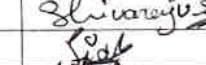
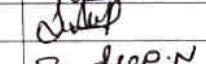
List of accompanying faculty

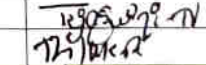
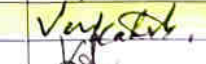
Sl. No.	Faculty Name	Designation	Signature
1	Mr. Tribhuvan K. R.	Assistant Professor, Biotechnology	
2	Mrs. Suman Narayan	Assistant Professor, Biochemistry	
3	Mr. Abhilash H S	Assistant Professor, Biotechnology	

List of BMBT students

Sl. No.	Name	Register No.	Mobile No.	Signature
1	BHARATH P	M2000725	9916838567	
2	BHARATHKUMAR M V	M2000726	6361436406	
3	BHUMIKA D	M2000730	7411080083	
4	CHANDAN K R	M2000737	9620418207	
5	CHEZHAN NAIK B O	M2000743	7678266169	
6	CHIRAG M L	M2000745	8217785646	
7	D S SHARATH	M2000747	9920060257	
8	DARSHAN GOWDA T M	M2000748	8861938150	
9	GAGANDEEP S M	M2000756	8073478484	
10	HARISHNAYAK T	M2000760	8088179251	
11	KIRAN N V	M2000779	8310037947	
12	KITTY V K	M2000780	8158833790	
13	KUMARASWAMY A C	M2000782	9591902053	
14	MADHU S R	M2000791	9972910342	
15	MAHESHPRASAD R	M2000796	0839625137	
16	MANOJ K	M2000800	7795042548	
17	MANOJ R	M2000806	6362354090	
18	MONISH KUMAR	M2000811	9591352020	
19	NAGACHANDRA G B	M2000813	8431316862	
20	NAGAHARSHA KARANTH K P	M2000814	7892684366	
21	NAVANEETH P K	M2000818	8192690569	
22	NAYANA S	M2000822	7899731173	
23	PUNEETH KUMAR N	M2000839	8151833790	
24	RAKESH S	M2000843	Absent	
25	RAKSHITHA H K	M2000846	9019665642	
26	RAVICHANDRA KUMAR N	M2000853	8792815320	
27	ROHITH M SHETTY	M2000857	9036828581	
28	SADHANA G A	M2000862	6361845843	
29	SHAMANTH C M	M2000869	9972828080	
30	SHANTHARAJU Y K	M2000870	7976417989	
31	SHIVARAJU S	M2000879	8147384683	
32	SIDDIQ PASHA	M2000884	6361848250	
33	SUDEEP B	M2000892	8105193556	
34	SUDEEP N	M2000894	8792572417	
35	SUDEEP S	M2000895	9019084773	
36	TEJASWINI N	M2000905	8660294885	
37	THILAK R	M2000908	7204352094	
38	VENKATESHA T	M2000911	9880873583	
39	YASHWANTH L	M2000920	9742846215	
40	VENKATESH PRASH M D	M1900578	Absent	

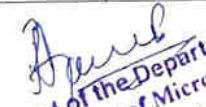
Head of the Department
Department of Microbiology
Saradavilas College, Mysore

Principal
Saradavilas College, Mysore

List of accompanying faculty

Sl. No.	Faculty Name	Designation	Signature
1	Mr. Tribhuvan K. R.	Assistant Professor, Biotechnology	17/6/23
2	Mrs. Suman Narayan	Assistant Professor, Biochemistry	17/6/23
3	Mr. Abhilash H S	Assistant Professor, Biotechnology	17/6/23

List of BMBT students

Sl. No.	Name	Register No.	Mobile No.	Signature
1	BHARATH P	M2000725	9916838567	
2	BHARATHKUMAR M V	M2000726	6361436406	
3	BHUMIKA D	M2000730	7411080083	
4	CHANDAN K R	M2000737		
5	CHEZHAN NAIK B O	M2000743	7483266169	
6	CHIRAG M L	M2000745	8217788646	
7	D S SHARATH	M2000747	9980040757	
8	DARSHAN GOWDA T M	M2000748	8861838150	
9	GAGANDEEP S M	M2000756	8073478434	
10	HARISHNAYAK T	M2000760		
11	KIRAN N V	M2000779	8310037947	
12	KITTY V K	M2000780		
13	KUMARASWAMY A C	M2000782		
14	MADHU S R	M2000791	9972910342	
15	MAHESHPRASAD R	M2000796		
16	MANOJ K	M2000800		
17	MANOJ R	M2000806		
18	MONISH KUMAR	M2000811		
19	NAGACHANDRA G B	M2000813	843131686	
20	NAGAHARSHA KARANTH K P	M2000814	7892684366	
21	NAVANEETH P K	M2000818	8792690569	
22	NAYANA S	M2000822	7899731173	
23	PUNEETH KUMAR N	M2000839		
24	RAKESH S	M2000843	Absent	
25	RAKSHITHA H K	M2000846	9019665642	
26	RAVICHANDRA KUMAR N	M2000853	8792815920	
27	ROHITH M SHETTY	M2000857	9036888581	
28	SADHANA G A	M2000862	6361845843	
29	SHAMANTH C M	M2000869		
30	SHANTHARAJU Y K	M2000870	7975417982	
31	SHIVARAJU S	M2000879	8147384683	
32	SIDDIQ PASHA	M2000884	6361848250	
33	SUDEEP B	M2000892	8105198556	
34	SUDEEP N	M2000894		
35	SUDEEP S	M2000895		
36	TEJASWINI N	M2000905	8660234885	
37	THILAK R	M2000908	7204352029	
38	VENKATESHA T	M2000911	9880875583	
39	YASHWANTH L	M2000920		
40	VENKATESH PRASH M D	M1900578	Absent	

Head of the Department
 Department of Microbiology
 Saradavilas College, Mysore

1

11:01 (4 hours ago) ☆ ↩ ⋮

Registrar [MAHE]
to Director, Pai Suresh, Satish, Director, Office, Manipal, Reception, me ▾

Madam,

Referring to your email below, Manipal Academy of Higher Education (MAHE), Manipal, permits 40 students of Shrada Vilas College, Mysore to visit the following places/colleges of MAHE on 16th June 2023, as a part of their syllabus (visit to industry/institutions):

- 1) Manipal School of Life Sciences (MSLS)
- 2) Planetarium
- 3) Manipal Experience Centre (MEC).

The accompanying faculty member can liaise with the staff members concerned at the respective Institute/facilities. Details are provided below:

@Director SOLS [MAHE-MSLS] (Contact No. 0820 2922058) for visit to MSLS

@Dr. T. M. A. Pai Planetarium [MAHE] (Contact No. 0820 2923557) for visit to Planetarium

@Suresh K [MAHE] (Contact No. 0820 2922469 or 9945271651) for visit to MEC.

With regards,

REGISTRAR



manipal.edu, Madhav Nagar, Manipal 576 104
Kamataka, India
Phone: +91 820 2922323 Fax: +91 820 2570062
Email: registrar@manipal.edu www.manipal.edu

PLEASE CONSIDER THE ENVIRONMENT BEFORE YOU PRINT THIS E-MAIL



Department of Biochemistry

SARADA VILAS COLLEGE
Krishnamurthypuram, Mysuru-570004
Affiliated to University of Mysore
Re accredited by NAAC with B⁺ grade (CGPA: 2.70)



Date: 05/01/2023
Place: Mysuru

From,

Likith clement
Head of Department
Biochemistry
Sarada Vilas College
Mysore-570004

To,

The Principal
Sarada Vilas College
Mysore-570004

Respected Madam,

Sub: Permission to visit Triphase Pharmaceuticals

With respect to the above subject, I request you to kindly permit the of First and second year BMBt Students to carry out the Field visit to the Triphase Pharmaceuticals and as a part of our study.

A total of 23 students will be part of the visit on 06/01/2023, accompanied by Suman, Assistant professor, Dept of Biochemistry. The list of students is acctached with this letter.

Kindly oblige to our request

Thanking you,

Your's faithfully

Likith Clement
Head of Department
Biochemistry
Sarada Vilas College
Mysuru-570004

SL NO	STUDENT NAME
1	Abhishek. K .L
2	Darshan.N
3	Shambu Vaishnav
4	Raghav raj S.G
5	Anju K.S
6	Bindu.C
7	Sachin V.V
8	Vinith Raj D
9	Adarsh T.K
10	Aishwarya K
11	Lakshmikanth K
12	Nisarga K.M
13	Kousalya S.C
14	Rohith Kumara
15	Chandan Kumar
16	Monica K
17	Yashwanth M
18	Chandana
19	Maria Amulya
20	Nischal
21	Ranjitha
22	Shobitha
23	Sheryas

Ken

To,

06th January 2023

Dr.Devika M

Principal

Sarada Vilas College

Krishnamurthypuram, Mysuru

Sub: Field Visit to Triphase Pharmaceuticals Pvt Ltd

Dear Dr,

As a part of study, a group of 23 students of first & second year BSc Biochemistry, Sarada Vilas College, Krishnamurthypuram, Mysuru had visited Triphase Pharmaceuticals Pvt Ltd, Mysuru on 06th January 2023 accompanied by Ms.Suman Assistant professor, Department of Biochemistry. Basic facility tour on how fermentation is carried out was explained.

Thank you

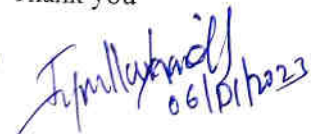
for 
06/01/2023

Irfanulla Sharieff

Chief Scientific Officer

Triphase Pharmaceuticals Pvt Ltd

Triphase Pharmaceuticals Private Limited

Regd off: # 694, Double road, Saraswathipuram, Mysore – 570 009, Karnataka. INDIA

Operations: Site No. Special 3, Property No. 482, KSSIDC Industrial Estate, Kasaba Hobli, Hebbal, Mysore-570 016, Karnataka State, India

Tel: Operations + 91-821-4191022.

SARADA VILAS COLLEGE

Krishnamurthypuram Mysore-570004

DEPARTMENT OF BIOCHEMISTRY

REPORT ON INDUSTRIAL VISIT



Submitted By,

Vinith Raj D

Reg No: U01BG21S0058

3rd Sem B.Sc. NEP (BCBT)

Submitted To,

Likith clement
Head of the Department
Biochemistry
Sarada Vilas College

SARADA VILAS COLLEGE

Krishnamurthypuram Mysore-570004

Department Of Biochemistry

CERTIFICATE

This is to certify that **Mr. Vinith Raj D** has participated in the Biochemistry Field Study and has submitted field report as a practical fulfilment of 2nd year B.Sc. NEP 3rd semester Biochemistry practical examination prescribed by the University of Mysore for B.Sc. degree course during the year 2022-2023.

Register No: U01BG21S0058

Date: 14/02/2023

Signature of the teacher in charge

1. 

2.

Head of Department

Likith Clement P M.Sc., B.Ed.
Head of the Department
Biochemistry
Sarada Vilas College
Mysuru - 570 004

Signature of the Examiner
24/2/2023

ACKNOWLEDGEMENT

We are extremely grateful for the Principal, **Dr. M Devika**, Sarada Vilas College, Mysore, for providing us the opportunity to visit the **Triphase Pharmaceutical Industry**, Hebbal Industrial Area, Mysore on **6th January 2023** for a one day industrial visit as per the requirements of the University of Mysore.

We give our sincere thanks to **Mr. Likith Clement**, Head of the department of **Biochemistry** for not only permitting us to go visit **Triphase Pharmaceutical Industry**, but also accompanying us in the visit. We are also thankful to our **Ms. Suman N**, Department of Biochemistry for her assistance and support during this visit.

Date: 06/01/2023

Place: Mysore

Thanking you,
Vinith Raj D

DECLARATION

I **Vinith Raj D** hereby declare that, I have taken part in the one-day industrial visit to **Triphase Pharmaceutical Industry, Mysore** on **6th January 2023** and am the sole author of this report.

I am submitting this report to Department of **Biochemistry, Sarada Vilas College, Mysore** in requisite to the syllabus requirement **Biochemistry Practical Paper-3** prescribed by the university of Mysore.

I also declare that I have not submitted this report or its like to any other department for the award of any degree.

Date: 14/02/2023

Place: Mysore

Vinith Raj D

3rd sem B.Sc. BCBT

Reg.No: U01BG21S0058

JOURNEY TO OUR VISIT

Industrial visit to Triphase Pharmaceuticals, Mysore

Class: 3rd SEM B.S.c. BCBT

Faculty: 1) Mr. Likith Clement

2) Ms. Suman N

Industry Visit: Industry Visited: Triphase Pharmaceuticals, Mysore

An industrial visit at **Triphase Pharmaceuticals, Hebbal, Mysore** was done by the Biochemistry department 3rd SEM students on 6th January 2023.

The industrial visits were witnessed by all students of the class. Who were accompanied by the faculty **Mr. Likith Clement** head of the department of Biochemistry and **Ms. Suman N**, department of Biochemistry, all the students were very excited and left the campus on 6th January 2023, 12:30 pm by cab.

The journey was very comfortable and enjoyable. As the time pass by we reached our destination Hebbal Industrial Area at 1:00 pm in industry visit we have learned so many things, such visit really added up to the little knowledge of the student and everyone.



CONTENTS

1. INTRODUCTION

2. PROBIOTICS

3. FERMENTOR AND ITS TYPES

4. UPSTREAM AND DOWNSTREAM PROCESSING

5. AUTOCLAVE AND ITS TYPES

6. EVAPORATOR

7. BIOCHEMICAL OXYGEN DEMAND (BOD)

8. DEEP FREEZER

9. LAMINAR AIR FLOW

10. CONCLUSION

INTRODUCTION

Triphase Pharmaceuticals Pvt Ltd



Triphase Pharmaceuticals Private Limited is led by professionals and accomplished scientists from the biotech and food industries. The Company specializes in the development of high temperature stable probiotics and their application under Strain boost TM technology. Its probiotics are designed to fortify food and beverages and are being further developed as dietary supplements and pharmaceutical products addressing a range of diseases. Triphase has a Research & development facility and dedicated manufacturing unit under construction in Mysore . Armed with a US patent (August 2018), European patent (2019) and Canadian patent (2021) the company looks forward to bringing good and scientifically validated products for increasing the health and wellness of the people.

Timeline:

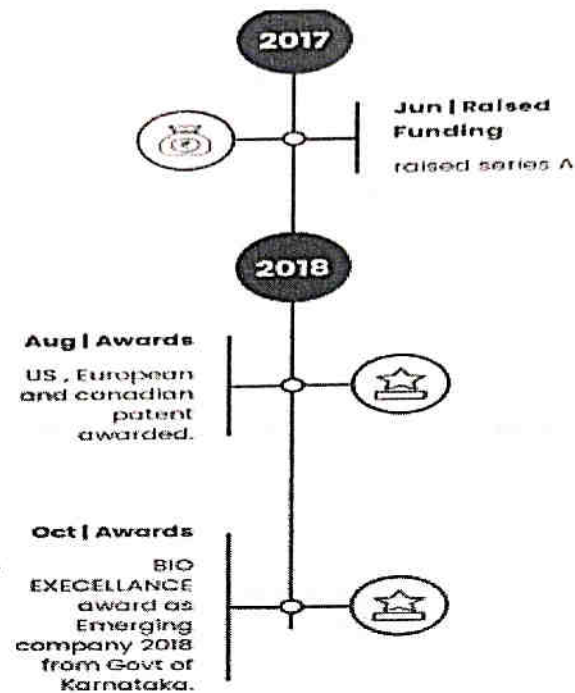

Probiotics

Probiotics are live microorganisms promoted with claims that they provide health benefits when consumed, generally by improving or restoring the gut microbiota. Probiotics are considered generally safe to consume, but may cause bacteria-host interactions and unwanted side effects in rare cases. There is some evidence that probiotics are beneficial for some conditions, but there is little evidence for many of the health benefits claimed for them.

The first discovered probiotic was a certain strain of bacillus in Bulgarian yoghurt, called *Lactobacillus bulgaricus*. The discovery was made in 1905 by Bulgarian physician and microbiologist Stamen Grigorov. The modern-day theory is generally attributed to Russian Nobel laureate Élie Metchnikoff, who postulated around 1907 that yoghurt-consuming Bulgarian peasants lived longer.

A growing probiotics market has led to the need for stricter requirements

for scientific substantiation of putative benefits conferred by microorganisms claimed to be probiotic. Although numerous claimed benefits are marketed towards using consumer probiotic products, such as reducing gastrointestinal discomfort, improving immune health,[8] relieving constipation, or avoiding the common cold, such claims are not supported by scientific evidence, and are prohibited as deceptive advertising in the United States by the Federal Trade Commission. As of 2019, numerous applications for approval of health claims by European manufacturers of probiotic dietary supplements have been rejected by the European Food Safety Authority for insufficient evidence of beneficial mechanism or efficiency.

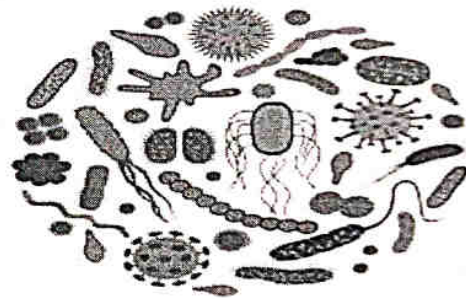
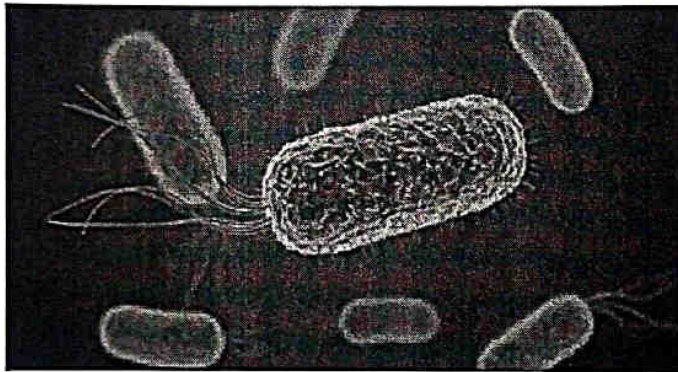

FERMENTERS and it's type

A Fermenter is a device that is used to carry out the fermentation process utilizing microorganisms, which is why it is also known as a "Fermenter or Bioreactor." It contains all of the components required for the commercial synthesis of compounds such as antibiotics, enzymes, and drinks in a variety of sectors.

The microorganisms in the fermenter are built in such a way that a larger value of the product can be formed with a minimal amount of media. It has a wide range of applications in the food sector, wastewater treatment, and so on. Fermentation is the process of bioprocessing raw substrates using microbial biomass (mostly yeasts and bacteria).

Types of Fermenters

Fermentation systems can be liquid (also called submerged) or solid (also called surface). The majority of fermenters used in industry are types of submerged fermenters, which conserve space and are easier to manage and build.

Submerged fermenters come in a variety of shapes and configurations, and they can be classified as aerated or anaerobic, batch or continuous. Aerated Stirred Tank Batch Fermenters are the most often utilized fermenters. There are five different types of fermenters:

- 1) Stirred tank fermenter
- 2) Airlift fermenter
- 3) Fluidised bed fermenter
- 3) Packed bed fermenter
- 4) Photo fermenter

Stirred Tank Fermenter

The motor drive shaft and a variable number of impellers make up this component (more than one). The diameter of the impellers is a third of the vessel's diameter. This bioreactor has a height-to-diameter ratio of around 3:5. A single opening in the tube attached externally allows air to enter the culture media. It makes it possible for the contents to be distributed more evenly throughout the ship .The following are some of its primary functions:

- Homogenization
- Solid-state suspension
- The medium is aerated
- Change of heat

Rotating stirrer and baffle can be located at the top or bottom of a stirred tank fermenter. It mostly employs a batch fermentation procedure.

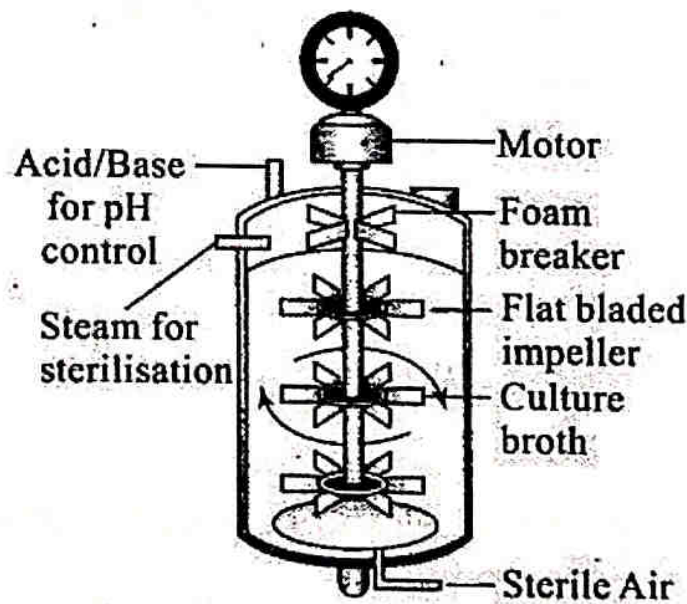

Simple stirred-tank bioreactor

Airlift Fermenter

It is made out of a single container that contains a hollow tube. "Draft tube" is the name for this hollow tube. At the bottom of the fermenter is a gas flow entrance that permits oxygen to pass through. The perforated disc or tube is connected to the gas flow input, allowing air to be distributed continuously.

Mechanical agitation arrangements are not present in this sort of bioreactor. The airlift name suggests that the medium is lifted aloft by the air. Internal liquid circulation channels allow the medium to move continuously. Fermentation takes place at a set volume and circulation rate in this environment.

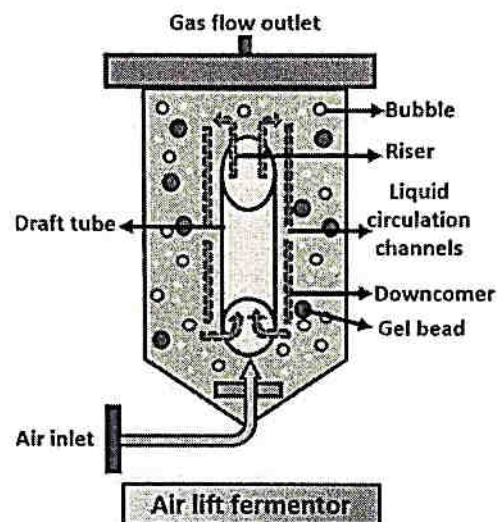

Advantages

- *Simple design with no moving parts or agitator for less maintenance, less risk of defects.
- *Easier sterilization (no agitator shaft parts)
- *Low Energy requirement vs stirred tank: Obviously doesn't need the energy for the moving parts (agitator shaft).

Fluidized Bed Fermenter

This bioreactor has a larger top section. The fluid's velocity is slowed by this expansion. It has a narrow bottom section. It's made in a way that:

Inside the vessel, the solid remains. And then there's a flow of liquid out the other end.

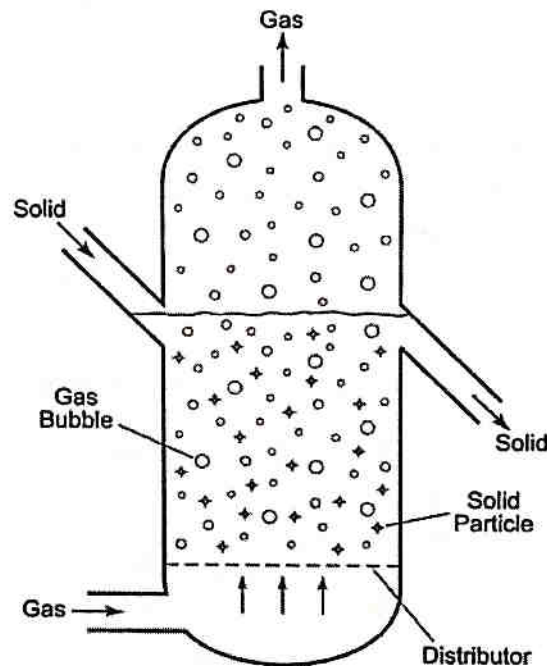

Advantages of Fluidized Bed Reactor:

Uniform Particle Mixing: Due to the intrinsic fluid-like behavior of the solid material, fluidized beds do not experience poor mixing as in packed beds. This complete mixing allows for a uniform product that can often be hard to achieve in other reactor designs. The elimination of radial and axial concentration gradients also allows for better fluid-solid contact, which is essential for reaction efficiency and quality.

Packed Bed Fermenter

It comprises a cylindrical vessel and a biocatalyst-packed bed. The properties of the solid matrix employed in the packed bed fermenter are as follows:

- 1) Non-porous or porous
- 2) Extremely compressible
- 3) Rigid

A nutrient broth constantly flows over the immobilized biocatalyst in this type of fermenter. Following that, a product is released into the fluid at the bottom of the culture jar, where it can then be retrieved. Fluid can flow upward or downward in this area.

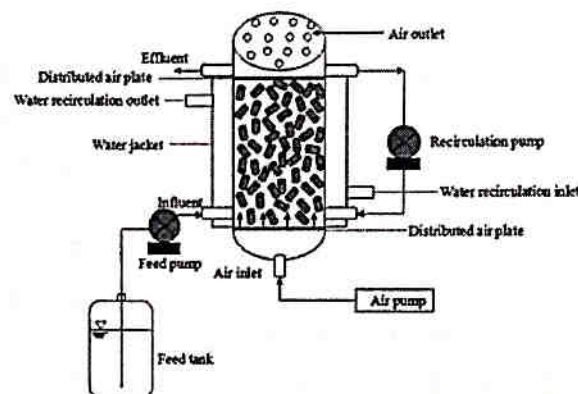
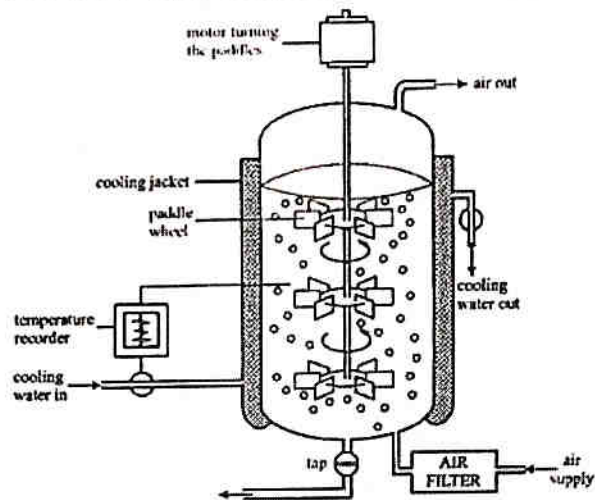

Photo Fermenter

This fermenter operates on the basis of light energy, which can be achieved through direct sunshine or artificial lighting. It's utilized to make p-carotene, astaxanthin, and other antioxidants. Glass or plastic make up the majority of this sort of bioreactor. The following components make up a photo fermenter:

- 1) Container
- 2) Tubes or Panels

Diagram of Photo Fermenter



Conclusion about FERMENTER

Hence, fermenters are a closed cylindrical tank that supports the biochemical and chemical activity of microorganisms to carry out the conversion of raw materials into usable products. Because it uses microbial biomass to complete the fermentation process, it is also known as a bioreactor. Fermentation procedures are separated into surface and submersion processes depending on the usage of stock culture. Surface fermentation involves growing biomass on the raw substrate's surface, whereas submersion fermentation involves growing microbes in the raw substrate.

Upstream & Downstream Processing

The production of active pharmaceutical ingredients (API) of biopharmaceuticals typically starts with generation of the API via living cells known as the upstream process, followed by purification of the target API, or the downstream process.

Upstream Processing

The initial steps of the upstream process start with milliliter quantities of mammalian or microbial cells engineered to produce a specific protein molecule. Using several cultivation steps in a controlled environment within a bioreactor, these cell cultures are grown to a volume of several thousand liters to produce several kilograms of the desired API.

*Mammalian Cell Culture:

Mammalian cell culture is used to produce large, complex proteins such as monoclonal antibodies. Utilization of mammalian cells allows for modification of the API, similar to those which may occur in human cells (e.g. glycosylation). Production processes with mammalian cell cultures take several days to weeks. Growth of these cells requires a complex and well-balanced mixture of nutrients as well as relatively gentle growth conditions regarding stirring and aeration.

Microbial Organisms:

Microbial organisms can grow much faster with cultivation times of several days or even hours. Smaller sized molecules such as peptides, enzymes, antibody fragments and protein scaffolds can be produced very efficiently. Microbial organisms are usually very robust and can grow to high cell densities generally several orders of magnitude beyond mammalian cell cultures. Microbial organisms typically have some limitations concerning the size of the protein and "human-like" modification of the molecules.

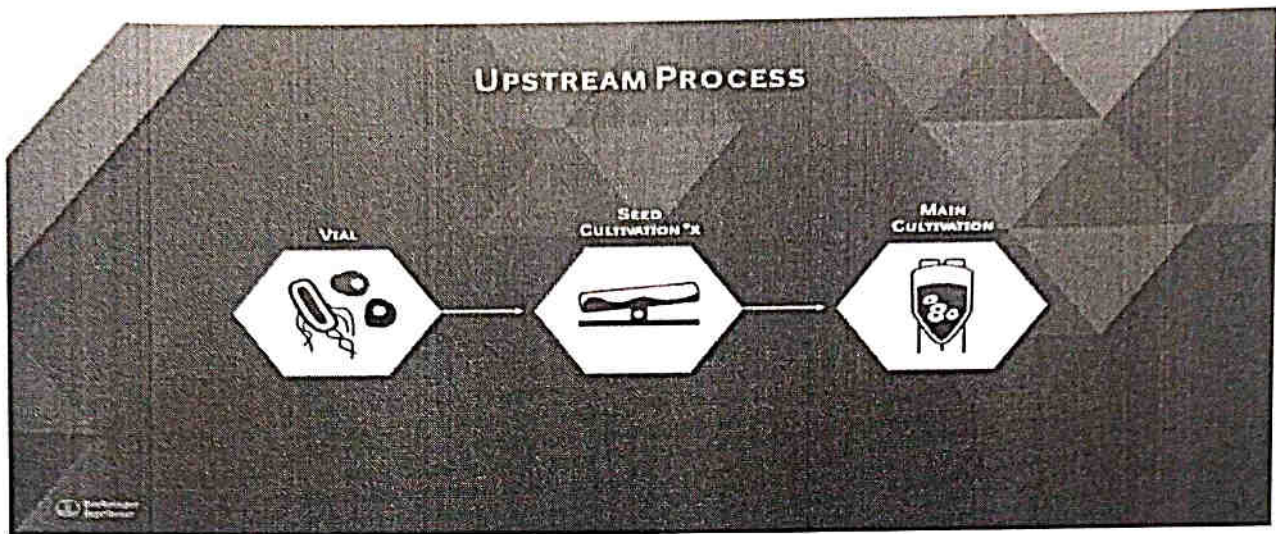

Downstream Processing

Following the generation of the protein or antibody molecule, isolation and purification from the complex mixture of host cell proteins, cells, cell debris, nutrients and waste materials must now take place.

Purification begins with separating the cells from the media. In most mammalian cultures, the protein is secreted into the media, thus the supernatant must be collected for further purification. In microbial production, the protein can also accumulate within the cells, therefore the cells need to be disrupted and the cell debris separated from the protein of interest. Insoluble products including unfolded, pure proteins sticking together, known as inclusion bodies must be refolded to achieve their native and active conformation. Precipitation steps based on temperature, pH, or chemical interaction can be used for removal of process related impurities.

The solution containing the protein of interest is purified using different techniques. Chromatographic separation steps are widely used; they are based on separation principles by charge, size or hydrophobicity of the protein, or by specific affinity to the chromatographic resin. A wide range of filtration techniques are used to separate the protein from the remaining

Autoclave

An autoclave is a device that works on the principle of moist heat sterilization, wherein saturated steam is generated under pressure in order to kill microorganisms such as bacteria, viruses, and even heat-resistant endospores from various types of instruments. This is done by heating the instruments within the device to temperatures surpassing the boiling point of water.

This process is also embodied by gas laws, which basically states that the higher the pressure is within the device, the higher the temperature increases. In other words, pressure and temperature are directly proportional to each other.

It is also important to note that it is the temperature that kills the microorganisms, not pressure. Rather, higher pressures are capable of increasing the boiling point of water, which thus increases the temperature of sterilization. High pressure also helps heat to rapidly spread within the material.

Autoclaves typically yield a temperature of about 121 degrees Celsius, taking about 15-20 minutes to complete the sterilization process. However, autoclave cycles may be adjusted accordingly by the working technician.

Types Of Autoclaves?

Though there are different types of autoclaves, all of them operate the same way. The type of autoclave depends on what setting they will be used in. Here are some of them:

- 1). Pressure Cooker Type (N-type).
- 2). Gravity Displacement Autoclave.
- 3). Positive Pressure Displacement Autoclave (B-type).

1). Pressure Cooker Type/Laboratory Bench

:- Autoclaves (N-type): This autoclave is commonly used around the world. It contains an air and steam discharge tap, a safety valve, and a pressure gauge. It also contains an electric immersion heater located at the bottom of the chamber.

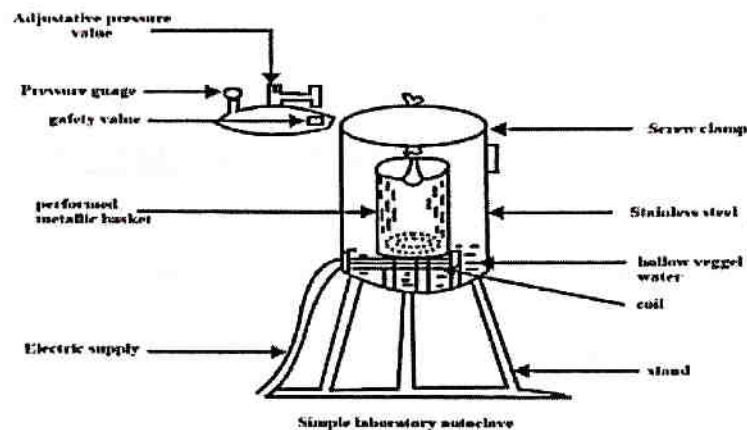

2). Gravity Displacement Autoclave:

:-These are commonly used in laboratories. This autoclave generates steam inside the chamber through a heating unit, which can move within the chamber for optimal sterilization. It is also relatively cheaper compared to other autoclaves.

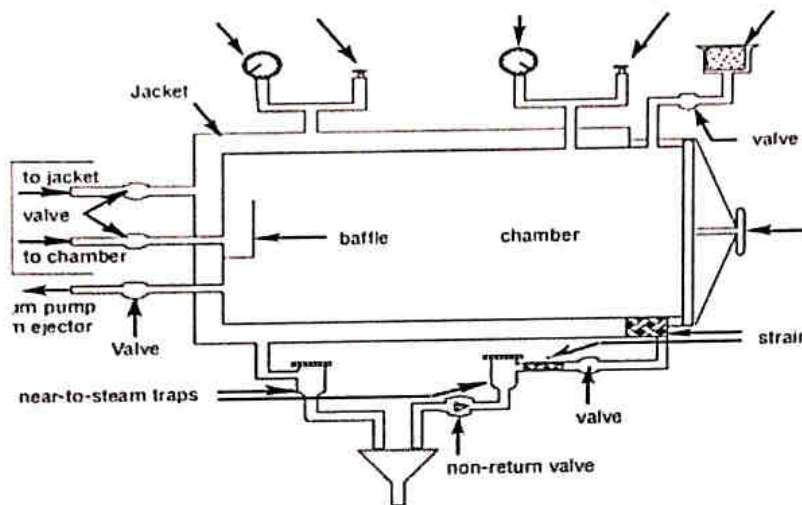

3). Positive Pressure Displacement Autoclave (B-type) :-

This type of autoclave generates steam in a separate steam generator unit, which then transfers the steam into the autoclave. It is known to be faster since steam can be generated in just seconds.

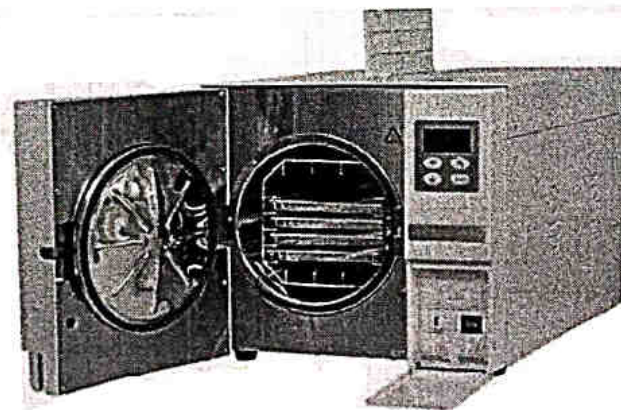

4). Negative Pressure Displacement Autoclave (S-type):

Negative pressure displacement autoclaves have both a steam generator and a vacuum generator. The vacuum generator sucks out all the air within the autoclave, while the steam generator, like the positive pressure displacement autoclave, generates heat and passes it into the autoclave. This autoclave is the most recommended, but also the most expensive.

EVAPORATORS

Evaporators are used to convert liquids into gaseous state via heat transfer. All of the basic evaporators have mechanism to separate liquid and vapor by means of a heat transfer. The raw material fed into the evaporator and passes through heated tubes. The heat evaporates the water within the raw material.

Application of evaporators

Evaporators are used widely in processing industries that work with fluids and chemicals. They work best in lowtemperature applications in food and pharmaceutical industries and in effluent treatment. Apart from manufacturing reliable and cost-effective evaporators for over two decades, Shachi has recently introduced the new self-cleaning evaporator in India in collaboration with Klaren International BV from Holland for effluent treatment.

Types of evaporators

- 1) Forced circulation evaporators
- 2) Rising film evaporator
- 3) Falling film evaporator
- 4) Agitated thin film evaporator
- 5) Self-cleaning evaporator.

Biochemical oxygen demand (BOD)

Biochemical oxygen demand (BOD) is the amount of dissolved oxygen (DO) needed by aerobic biological organisms to break down organic material present in a given water sample at a certain temperature over a specific time period. The BOD value is most commonly expressed in milligrams of oxygen consumed per liter of sample during 5 days of incubation at 20 °C and is often used as a surrogate of the degree of organic pollution of water. BOD reduction is used as a gauge of the

effectiveness of wastewater treatment plants. BOD of wastewater effluents is used to indicate the short-term impact on the oxygen levels of the receiving water.

BOD analysis is similar in function to chemical oxygen demand analysis, in that both measure the amount of organic compounds in water. However, COD analysis is less specific, since it measures everything that can be chemically oxidized, rather than just levels of biologically oxidized organic matter.

DEEP FREEZER

Deep freezers are the testing equipment that are used to preserve and store food products, medical equipment, blood samples, medicines and injections, etc. for a long period of time. Deep Freezers are used for industrial purposes as well as for household purposes. Moreover, deep freezers are also used in restaurants and supermarkets to preserve the raw food for a long period of time.

There are numerous types of deep freezers such as blood bank refrigerators, freezer drier, ultra-low deep freezer, deep freezer vertical and many more. These devices are available in different sizes and shapes sometimes it is designed with compact designs and sometimes with regular designs. The specifications and functions of the instruments varies as per the requirements of the test application.

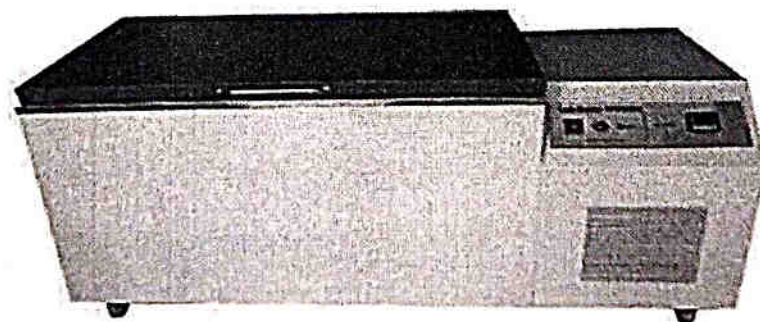

LAMINAR FLOW AIR

Laminar air flow is an equipment that is generally used in Microbiology laboratories. It consists of a chamber with an air blower attached to its rear side that allows the flow of air with a uniform velocity in straight lines that are parallel to each other. The main purpose of a laminar flow cabinet/hood is to form a contaminant-free work environment. For this purpose, it filters and captures all types of impurity particles entering the cabinet. It makes use of a filter pad and a special filter system known as a high-efficiency particulate air filter or HEPA filter, which can remove the airborne impurity particles that are up to 0.3 micrometers in size. A laminar air flow chamber is also known as a laminar flow closet or a tissue culture hood.

A laminar flow cabinet or tissue culture hood is a carefully enclosed bench designed to prevent contamination of semiconductor wafers, biological samples, or any particle sensitive materials. Air is drawn through a HEPA filter and blown in a very smooth, laminar flow towards the user. Due to the direction of air flow, the sample is protected from the user but the user is not protected from the sample. The cabinet is usually made of stainless steel with no gaps or joints where spores might collect.

It consists of a chamber with an air blower attached to its rear side that allows the flow of air with a uniform velocity in straight lines that are parallel to each other. The main purpose of a laminar flow cabinet/hood is to form a contaminant-free work environment.

LAMINAR AIR FLOW APPLICATIONS

Laminar air flow systems are used in various applications such as life science research, mushroom cultivation, microbiology, IVF, IUI and

histopathology / pathology lab, plant tissue and cell culture and pharmaceutical and electronics industry and many more.

TYPES OF LAMINAR AIR FLOW

Vertical Laminar Air flow

It is the most used type of laminar air flow. In vertical flow cabinet, room air is entered in working area through HEPA filter fitted on top of the cabinet. Thus, air flows downward (vertically) towards work surface and leaves the cabinet sweeping out particles and bacteria.

Vertical Laminar Flow Cabinet

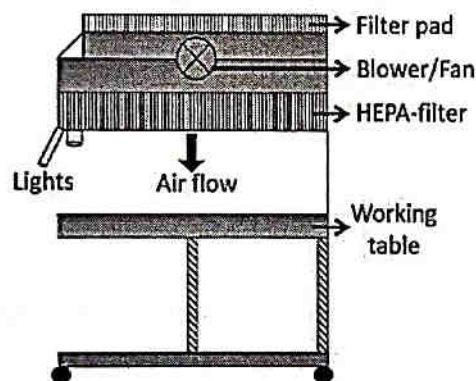

Horizontal laminar air flow

In horizontal laminar air flow cabinet, room air is entered in working area through HEPA filter fitted on the back side of the cabinet. Filtered air flows horizontally towards the user creating sterile working environment.

Horizontal Laminar Flow Cabinet

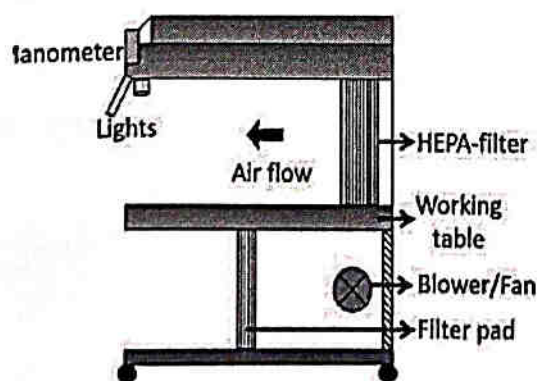

Conclusion

The industrial tour was the interface between the college life and the corporate world. All those who attended experienced the moment. It was clear that all the basic and fundamental of each subjects and Management tactic should be learnt thoroughly. students learnt how production process works, what are the current Scenario of Market, which management tactic should be selected for career. They told us what the needs of the management, what they are expecting from us as the freshers. They guided us how to prepare for the corporate world after completing education.

And we are learned about different types of Fermenters and it's use, Then we learned about Probiotics and there use and how we are using then in your Pharmaceutical industries. Then we all so seen CENTRIFUGE, A centrifuge is a device that uses centrifugal force to separate various components of a fluid. And we seen various types of AUTOCLAVE, An autoclave is a machine used to carry out industrial and scientific processes requiring elevated temperature and pressure in relation to ambient pressure and/or temperature.

Then we observed Biochemical oxygen demand (BOD), Biochemical oxygen demand (BOD) is the amount of dissolved oxygen (DO) needed (i.e. demanded) by aerobic biological organisms to break down organic material present in a given water sample at a certain temperature over a specific time period.

The experience of this tour was really fantastic and unforgettable. It was reverberating experience which cherished all of us. I got valuable information from this industrial tour and they guided us how to stand in the corporate world in the era of competition. I got to learn a lot many more things from this tour.



CADD SOLUTIONS TECHNOLOGIES PVT LTD.,

Certified by ISO 9001:2015 & OHSAS 18001:2007

• Chemical & Environmental lab • Mechanical Testing Lab • Calibration Services
• Food Testing Lab • Digital (DGPS) Survey • Road & Amenity cleaning M/c



Ref. No.: CSTPL/INTRNSP/008/2023-24

Date:

To,
The Principal
Sarada Vilas College,
Krishnamurthypuram, Mysuru.

Respected Sir/Madam,

Sub - Letter of Permission for an Internship Programme for Environmental Monitoring at our Laboratory.

We M/s. **CADD Solutions Technologies Pvt. Ltd.**, an National Accreditation Board for Laboratory (NABL) accredited lab as per ISO/IEC:17025:2017 and also certified by ISO 9001:2015 & OHSAS 18001:2007 established in 2018 and is privately setup, Independent company that provides the highest value and quality environmental monitoring, testing, analysis assessment services to benefit both citizens and the natural environment. It operates in a flexible, innovative manner that is responsive to the needs and expectations of individuals/customers. In future we will be having an MOEF Accreditation Laboratory under EPA rules.

We also conducting the Internship programme from last 4 years and around 1000 students attended the internship programme at our laboratory.

I, as the Director of **CADD Solutions Technologies Pvt. Ltd.**, writing this letter to request you to give an opportunity to conduct an Internship program on **“Hands on Training on Analysis of both Chemical and Microbiology Lab and Air & Stack Monitoring”** in our Premises.

The Internship program is conducted by our Professionally Trained Staffs on payable basis.

They will get to learn about the situation in our current environment.

This will be a great chance for the students to know more about the environment and even be aware of the problems happening in the environment.

Corporate Office

#9522, New No.-CH B/1, 2nd Main Road,
Lakshminpuram, Mysuru - 570004
0821-4281199 / +91 7538191592 / +91 9591084777

Branch Office

#3419, Service Road, Near Attijuppe Metro Station
RPC Layout, Vijayanagar, Bengaluru - 560040
090 - 29558633 / +91 7328191333



CADD SOLUTIONS TECHNOLOGIES PVT LTD.,

Certified by ISO 9001:2015 & OHSAS 18001:2007

• Chemical & Environmental lab • Mechanical Testing Lab • Calibration Services
• Food Testing Lab • Digital (DGPS) Survey • Road & Amenity cleaning M/c



We will also get to know what students think about the environment and what solutions or ideas they have to overcome the problems through this.

This letter requests the internship program to be held at our lab. We would like to say to you that this Training program will bring many changes to the students.

From this Training, we will also get to know about their opinion towards our environment. Lastly, I would request you to please accept our letter and permit your students to take this opportunity to improve their skill and knowledge towards Analysis of Chemical and Microbiology Testing.

After successful completion of the internship program, we will be issuing a certificate to students.

If you have any further queries, you can reach me at 7338191592 / 6364236007 or through an email cstpl18@gmail.com

Thanking you

For CADD Solutions Technologies Pvt. Ltd.,

Director

Our New Office Address:

414 Ch5, 415 Ch6, 4151 Ch6, Chamaraja Double Road, Dewans Road Corner,
Chamaraja Mohalla, Mysore 570024.

Corporate Office

#332/2, New No. CH 9/1, 2nd Main Road,
Lakshminipura, Mysuru - 570004
0821-4287199 / +91 7338191592 / +91 9891094777

Branch Office

#3419, Service Road, Near Attiguppe Metro Station
HPC Layout, Vijayanagar, Bengaluru - 560040
080 - 20858631 / +91 7338191593

0

Krishnamurthy puram
College

24/04/2023

Sl. No.	Time IN	Time OUT	NAME	Qualification	Sign
1	10:30	12:55	Koushik. Rao. G U01BQ21S0005	II BSc	<i>[Signature]</i>
2	10:30	12:55	Adarsh T.K U01BQ21S0007	II BSc	<i>[Signature]</i>
3	10:30	12:57	Raghava Raj. R. G U01BQ21S0001	II BSc	<i>[Signature]</i>
4	10:30	12:57	Samithra Veishnar U01BQ21S0002	II BSc	<i>[Signature]</i>
5	10:30	12:55	Lakshmi Karthak U01BQ21S0022	II BSc.	<i>[Signature]</i>
6	10:30	12:55	Ravikumara. S U01BQ21S0037	II B.Sc.	<i>[Signature]</i>
7	10:30	12:55	Chandana Kumara K.K U01BQ21S0090	II B.Sc.	<i>[Signature]</i>
8	10:30	12:55	Darshan. N U01BQ21S0003	II B.Sc	<i>[Signature]</i>
9	10:30 to 12:55		chithra. m U01BQ21S0078	II B.Sc	<i>[Signature]</i>
10	10:30 to 12:55		chaitra. K U01BQ21S0009	II. B.Sc	12:55 PM <i>[Signature]</i>
11	10:30	12:55	Nisarga. k.M. U01BQ21S0059	II. B.Sc.	<i>[Signature]</i>
12	10:30	12:56	Aishwarya. K U01BQ21S0004	II BSc	<i>[Signature]</i>
13	10:30	12:55	Devanar Priya. D U01BQ21S0008	II BSc	<i>[Signature]</i>
14	10:30	12:58	Harshitha. T.V U01BQ21S0103	II BSc	<i>[Signature]</i>

→ Introduction to Computer & Instruments

→ Conductivity

→ Colour & odour

Vinod 24/4/2023

Bevanna
21/04

Amritha

College Name: Sarada Vilas College
 Krishnamurthy Puram, Mysore

UIC. 20104K023

Sl. No	Time IN	Time OUT	NAME	Qualification	Sign
1	10:00	1:00	Koushik. Rao. G.	II BSc	B. Koushik
2	10:00	1:00	Adarsh. T. K.	II BSc	Adarsh
3	10:00	1:00	Raghava Raj. S. G.	II BSc	Raghava
4	10:00	1:00	Sambhu Vaishnav.	II BSc	Sambhu
5	10:00	01:00	Lakshmi Kanth. K.	II BSc	Lakshmi
6	10:00	01:00	Ravikumara. S.	II B.Sc	Ravi
7	10:00	1:00	Chandan Kumara. K. K.	II BSc	Chandan
8	10:00	1:00	Darshan. N	II B.Sc	Darshan
9	10:00 to 4:00		Chithra. M	II B.Sc	Chithra
10	10:00	1:00	Chaitra. K.	II BSc	Chaitra
11	10:00	1:00	Nisarga. K. M	II BSc	Nisarga
12	10:00	1:00	Aishwarya. K.	II BSc	Aishwarya
13	10:00	1:00	Devanah Poyya. D.	II BSc	Devanah
14	10:00am	1:00pm	Harshitha. T. U.	II BSc	Harshitha

- TH, Calcium, Magnesium
- Alkalinity as CaCO₃
- Chloride.

UIC. 20104K023
 Koushik
 25/04

Harshitha
 25/04

College name: Surada Veda College
 Krishnamurthyapuram, Mysore

26/04/2023

Sl. No.	Time IN	Time OUT	NAME	Qualification	Sign
1	10:00am	1:31	Koushik Rao. G	II B.Sc	
2	10:00	1:34	Adarsh. T. K.	—	
3	10:00	1:31	Raghava Raj. S. G	—	
4	10:00	1:34	Sambhu Vaishnav	II BSc	
5	10:00	1:35	Lakshmi Kanth. K	II BSc	
6	10:00	1:31	Ravikumara. S.	II B.Sc	
7	10:00	1:34	Chandan Kumara K. K	—	
8	10:00	1:32	Darshan. N	II BSC	
9	10:00to	1:31	Chithra. M	II B.Sc	
10	10:00to	1:31	Chaitra. K.	—	
11	10:00	1:31	Nisarga. K. M	—	
12	10:00	1:32	Aishwarya. K.	—	
13	10:00	1:31	Devaran Priya. D	—	
14	10:00am	1:31pm	Harshitha. T. U.	—	

— Sulphates

— Sodium

— Fluoride

— ~~Phosphates~~

— Potassium

W. K.
26/04/2023

Kevenna
1/2/2023

H. K.
1/2/23

KRISHNAMURTHY PURAM.

Sl. No.	Time In	Time out	Name	Qualification	Sign.
1	10:00	1:10	Chandan Kumara K.K	II BSC	Chand
2	10:00	1:11	Devanampriya D	II BSC	Devan
3	10:00	1:09	Chaitra K	II BSC	Chaitra
4	10:00	1:09	Nisarga K.M.	II BSC	Nisarga
5	10:00	1:10	Darshan N	II BSC	Darshan
6	10:00	1:10	Adarsh T.K	II BSC	Adarsh
7	10:00	1:12	Harshitha T.U	II BSC	Harshitha
8	10:00	1:12	Chithra M	II BSC	Chithra
9	10:00	1:12	Ashwarya K	II BSC	Ashwarya
10	10:00	1:13	Ravikumara S	II BSC	Ravik
11	10:00	1:14	Lakshmi Kantha K	II BSC	Lakshmi
12	10:00	1:12	Koushik Rao G	II BSC	Koushik
13	10:00	1:13	Sombhu Vaishnav	II BSC	Sombhu
14	10:00	12:30	Raghava Raj S.G	II BSC	Raghava

- phosphate
- Nitrite
- Boron

- Alkalinity as HCO_3

Vinuk
and others

Devanna

College, name - Krishna Murthy Puram
 Krishna Murthy Puram
 Mysore

28/04/2023

Sl No.	Time IN	Time OUT	NAME	Qualification	Sign
1	10:00	2:15	Chandan Kumara K.K.	II B.Sc.	
2	10:00	2:15	Devanampriya D	—	
3	10:00	2:15	Chaitra K	—	
4	10:00	2:15	Nisarga K.M	—	
5	10:00	2:15	Darshan N	—	
6	10:00	11:45 AM	Adarsh T.K.	—	—
7	10:00	2:15	Harshitha T.V	—	
8	10:00	2:15	Chithra M	—	
9	10:00	2:15	Aishwarya K.	—	
10	10:00	2:15	Ravikumara S.	—	
11	10:00	2:15	Laksmikantha K.	—	
12	10:00	2:15	Koushik Rao G.	—	
13	10:00	2:15	Sambhu Vaishnav	—	
14	10:00	2:15	Raghava Raj S.G.	—	
			— COD	— Hexavalent chromium	
			— BOD		
			— Iron		

Kevanna

Manjunee

Krishnamurthyapuram
Mysore

Date: 21/07/2019

Sl. No.	Time IN	Time OUT	NAME	Qualification	Sign
1	10:00	3:15	Chandan Kumar. K. K	B. Sc. (1 st year)	
2	10:00	3:00 PM	Devanam priya. D	—————	
3	10:00	3:08 PM	Chaitra. K.	—————	
4	10:00	3:8	Nisarga. K. M	—————	
5	10:00	3:20	Darshan. N	—————	
6	10:00	3:20	Adarsh. T. K.	—————	
7	10:00	3:20	Harshitha. T. U	—————	
8	10:00	3:15	Chithra. M	—————	
9	10:00	3:10	Aishwarya. K.	—————	
10	10:00	3:15	Ravikumara. S.	—————	
11	10:00	3:15	Lakshmi kantha. K.	—————	
12	10:00	3:08	Koushik Rao. G	—————	
13	10:00	3:15	Sambhu Vaishnav	—————	
14	10:00	3:15	Raghava raj. S. G	—————	

- TDS
- O & S
- Organic & Inorganic Solids
- Nitrate
- Acidity

Harjushree

Krishnamurthy puram
Mysore

02/05/2023

Sl. No	Time IN	Time OUT	NAME	Qualification	Sign
1	10:00	2:30	Chandan Kumar. K.K	II nd year B.Sc.	chud
2	10:00	2:35	Devanam priya. D	—————	
3	10:00 10:00	2:30	Chaitra. K	—————	
4	10:00	2:30	Nisarga. K.M	—————	
5	10:00	2:30	Darshan. N	—————	
6	10:00	2:30	Adarsh. T.K.	—————	
7	10:00	2:30	Harshitha. T.V	—————	
8	10:00	2:27	Chithra. M.	—————	
9	10:00	2:28	Aishwarya. K.	—————	
10	10:00	2:30	Ravikumara. S	—————	
11	10:00	2:30	Lakshnikantha. K.	—————	
12	10:00	2:30	Koushik Rao. G.	—————	
13	10:00	2:30	Sambhu Vaishnav	—————	
14	10:00	2:30	Raghava raj. S.G.	—————	

- pH
- Turbidity
- Sodium Adsorption ratio
- Residual Sodium Carbonate
- TSS

Harishree P
21-5-2023

College Name: - Anna Vyas College
 Krishnamurthy puram
 Mysore

Date: 03/05/2021

Sl No.	Time IN	Time OUT	NAME	Qualification	Sign
1	10:00	2:35	Chandan Kumar K.K MBBC	II nd year B.Sc.	chund
2	10:00	2:36	Devanam priya D. BZ	—————	A
3	10:00	2:35	Chaitra. K. BZ	—————	Chaitra
4			Nisarga K.M BCBT	—————	N
5	10:00	2:35	Dasshan. N MBBC	—————	D
6	10:00	2:35	Adarsh. T.K. BCBT	—————	A
7	10:00	2:35	Harshitha. T.U MBBT	—————	H
8	10:00	2:34	Chithra. M BZ	—————	Ch
9	10:00	2:35	Aishwarya. K. MBBC	—————	A
10	10:00	2:35	Ravikumara. S MBBT	—————	R
11	10:00	2:35	Lakshmi kantha. K. BCBT	—————	L
12	10:00	2:35	Koushik Rao. G MBBT	—————	Koushik
13	10:00	2:35	Sambhu Vaishnav BCBT	—————	S
14	10:00	2:35	Ragharaj. S.G. BCBT	—————	R
			— Microbiology	— Residual Chlorine	
			— Ambient Monitoring	— Dissolved Oxygen	
			— Stack Monitoring		

Harishchand

Krishnamurthy prasad
Mysore

04/05/2021

Sl. No.	Time IN	Time OUT	NAME	Qualification	Sign
1	10:00	1:40	Chandan Kumar. K.K	I BSc	
2	10:00	1:40	Devanah praya D	II BSc	
3	10:00	1:42	Chaitra. K.	II BSc	
4	10:00	1:41	Nisarga K.M	II BSc	
5	10:00	2:00	Darshan. N	II BSc	
6	10:00	1:42	Adarsh. T.K	- II -	
7	10:00	1:45	Harshitha. T.V	II BSc	
8	10:00 to	1:42	Chithra. M	II B.Sc	
9	10:00	1:40	Aishwarya. K	II BSc	
10	10:00	1:40	Ravikumara. S	- II -	
11	10:00	1:40	Lakshnikantha. K.	- II -	
12	10:00	1:40	Koushik Rao. G	II BSc	G. Koushik Rao
13	10:00	2:00	Sambhu vaishnav	II BSc	
14	10:00	2:00	Ragharaj. S.G.		
- Test					

Sl. No.	Time IN	Time Out	Name	Qualification	Sign
1	10:00	2:10	Chandan Kumar K.K MBBC	III rd year BSc	cha
2	10:00	2:45	Devanam priya D BZ	— " —	☞
3	10:00	2:15	Chitra . K BZ	— " —	☞
4	10:00	1:37	Nisarga K.M BCBE	— " —	☞
5	10:00	2:45	Darshan . N MBBC	— " —	☞
6	10:00	1:50	Adarsh . TK BCBE	— " —	☞
7	10:00	1:36	Harshitha . T.U	— " —	☞
8	10:00	1:40	Chithra . M	— " —	☞
9	10:00	2:30	Aishwarya . #	II nd BSc	☞
10	10:00	1:35	Ravi Kumar S	— " —	☞
11	10:00	1:40	Lakshmi kanth - K	— " —	☞
12	10:00	1:40	Koushik Rao. G	— " —	☞
13	10:00	2:15	Shambhu Vaishnav	— " —	☞
14	10:00	1:57	Raghavraj . S.G.	— " —	☞



CADD SOLUTIONS TECHNOLOGIES PVT. LTD.

NABL Accredited Laboratory as per ISO/IEC : 17025:2017 [TC - 8320] [Certified by ISO 9001:2015 & OHSAS 18001:2007]

414 CH5, 415 CH6, 4151 CH6, Chamaraja Double Road, Dewans Road Corner, Chamaraja Mohalla, Mysore 570024

☎ 0821 - 4281199

📞 73381 91592

✉ cstpl18@gmail.com

🌐 www.cstpl18.com

OUR SERVICES : Chemical and Environmental Lab | Mechanical Testing Lab | Calibration Services
DGPS / Total Station Survey | Road and Amenity Cleaning M/c.

Certificate

This is to certify that **Ms Aishwarya K**, bearing Registration No. **U01BG21S0004**, studying **II B.Sc (MBBC)** in **Sarada Vilas College, Krishnamurthyapuram, Mysuru**, has undergone a Hands on Training on **Water analysis of both Chemical & Microbiology Lab and Air, Stack and Noise Monitoring** in our Organization, for a period of 10 days, from **24. 04. 2023** to **05. 05. 2023**. Her conduct was found to be satisfactory during the tenure of internship.

Environmental Engineer

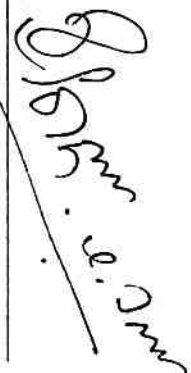
Quality Manager

Managing Director

REPORT
ON
ENVIRONMENTAL MONITORING USING
STANDARD METHOD



SUBMITTED BY

B.Sc. 4th SEMESTER STUDENTS

SARADA VILAS COLLEGE

MYSORE -570004

SUBMITTED TO

DEPARTMENT OF BIOCHEMISTRY

SARADA VILAS COLLEGE

MYSORE -570004

CONTENT

1. Introduction of CADD Solutions Technologies Pvt. Ltd.,
2. Acknowledgment
3. Introduction
4. Materials and methods

Techniques

- Water analysis
- Ambient air monitoring
- Noise level monitoring
- Microbiology analysis
- Stack monitoring

5. Conclusion



Sri. DASHARATH K, Founder & Director

CADD SOLUTIONS TECHNOLOGIES PVT. LTD., 414, Chamaraja Double Road Mysore Karnataka 570024, is a private setup, independent company that provides the highest value and quality environmental monitoring, testing, analysis assessment services to benefit both citizens and natural environment .It operates in a flexible in a, innovative manner that is responsive to the needs and expectations of individuals and customers. It is NABL Accredited laboratory as per ISO/IEC:17025:2005 (TC-8320) and is certified by ISO 9001:2015 & OSHAS 18001:2007.

Mission

To achieve steady growth benefiting our clients, our employees, and our company in the healthiest safest manner possible by providing quality data that is accurate, timely and highest integrity.

Vision

To become one of the leading environmental laboratory and development to carry forward a healthy environment to our future generations. We value our employees with a mutual trust provide the necessary resources to achieve this.

CADD solutions Technologies Pvt. Ltd., Team has bagged “**TIMES BUSINESS AWARDS**”, MYSURU 2020 from TIMES OF INDIA.

CADD uses the standard method for the examinations of water samples
*APHA-American Public Health Association & AWWA–American water Works Association.

ACKNOWLEDGEMENT

I would like to express my special thanks of gratitude to **Dr. Devika M**, Principal, Sarada Vilas College, Mysore, for providing me the golden opportunity to do this wonderful Internship on the "**Environmental Monitoring using Standard Methods**", I also thank to **Mr. Likith Clement** HOD of Department of Biochemistry, I also thank to **Capt. R.A. Manjunath**, Department of Microbiology and Biotechnology, **Mr. Yashwanth V M** assistant professor, Department of Botany, for their constant support and encouragement in making this Internship successful. Special thanks to **Mr. Dasharath K**, Founder and Managing Director, CADD Solutions Technologies Pvt. Ltd., **Mrs. Manjushree D**, **Mrs. Saritha S**, **Ms. Vinutha K**, **Ms. Devamma K.S** and for their excellent training that has helped me enhance my confidence in handling Internship. I am grateful to "CADD Solutions Technologies Pvt. Ltd." For providing me excellent lab facilities to carry out the project I would also like to express my sincere thanks to my Friends who helped me a lot in finalizing this Internship within the limited time.

Date: 16-05-2023

Place: Mysore





SARADA VILAS COLLEGE

Krishnamurthypuram, Mysore -570004

CERTIFICATE

This is to certify that A group of 14 students from SARADA VILAS COLLEGE has carried out internship on 'ENVIRONMENTAL MONITORING USING STANDARD METHODS' and has submitted the report to CADD Solutions Technologies Pvt. Ltd., during the year 2023-24.

Signature of Principal
Dr. M Devika
M.Sc., M.Phil., Ph.D.
Principal
Sarada Vilas College,
Krishnamurthypuram, Mysuru

Signature of Project In-charge

Date: 10/04/2023

Madhu Kumar G
S/o Gurumallappa,
Basavana Beedhi, 10th Ward,
Karinanjapura, Somavarapete Post,
Chamarajanagar - 571313

Dear Madhu Kumar,

Sub: Internship Offer Letter

We are pleased to offer you an internship as **Trainee Software Engineer** with **Ogma Technologies LLP, Mysuru**. Your internship shall **commence on 12-04-2023** and shall **end on 12-10-2023**. You will work 25 hours per week totaling 650 hours for the duration of the internship.

Since this is a paid internship, you will be provided a stipend of Rs. 4,000/- per month.

During your internship period with Ogma Technologies LLP, you may have access to trade secrets and confidential or proprietary business information belonging to Ogma Technologies LLP. By accepting this offer, you acknowledge that this information must remain confidential and agree to refrain from using it for your own purposes or disclosing it to anyone outside of Ogma Technologies LLP. Also, you agree that upon completion of your internship, you will promptly return any company-issued property and equipment along with information and documents belonging to the company. The internship cannot be construed as an employment or an offer of employment with Ogma Technologies LLP.

We look forward to having you begin your career at Ogma Technologies LLP and wish you a successful internship. Welcome to our team!

Please confirm your acceptance of the terms of this offer by **12-04-2023** failing which, we have the right to cancel the internship.

Regards,

Rakesh R
Ogma Technologies LLP



Ogma Technologies LLP

#1465, 18th Cross, Roopanagara

Mysore - 570026 (India)

Tel: +91 9449-701-802

Email: contact@ogmatech.in

Website: www.ogmatech.in

Date: 10/04/2023

Mahendra M
S/o Mahadevaswamy,
#48, Bandigowdanahalli,
Amachavadi,
Chamarajanagar - 571127

Dear Mahendra,

Sub: Internship Offer Letter

We are pleased to offer you an internship as **Trainee Software Engineer** with **Ogma Technologies LLP, Mysuru**. Your internship shall **commence on 12-04-2023** and shall **end on 12-10-2023**. You will work 25 hours per week totaling 650 hours for the duration of the internship.

Since this is a paid internship, you will be provided a stipend of Rs. 4,000/- per month.

During your internship period with Ogma Technologies LLP, you may have access to trade secrets and confidential or proprietary business information belonging to Ogma Technologies LLP. By accepting this offer, you acknowledge that this information must remain confidential and agree to refrain from using it for your own purposes or disclosing it to anyone outside of Ogma Technologies LLP. Also, you agree that upon completion of your internship, you will promptly return any company-issued property and equipment along with information and documents belonging to the company. The internship cannot be construed as an employment or an offer of employment with Ogma Technologies LLP.

We look forward to having you begin your career at Ogma Technologies LLP and wish you a successful internship. Welcome to our team!

Please confirm your acceptance of the terms of this offer by **12-04-2023** failing which, we have the right to cancel the internship.

Regards,

Rakesh R
Ogma Technologies LLP

Access 2 Justice Technologies & Solutions

Date: April 21, 2023

Shreyas Rao H Mohite
Sarada Vilas College, Krishnamurthy Puram,
Mysuru, Karnataka 570004

Dear Shreyas Rao H Mohite,

It is our pleasure to formally take you onboard as a **Project Intern – ML Team**, with effect from **01/05/2023** and a monthly stipend of **Rs. 10,000/-** (Rupees Ten Thousand Only) for a period of three months. There will be an additional bonus of up to 50% of your fixed pay (i.e., INR 5000), subject to your contributions and performance during the internship program as evaluated by your project lead. During this program you will be provided with opportunities to contribute to the ongoing projects at Access 2 Justice and/or do the proof-of-concept (POC) on niche technologies. By the end of the program, you are expected to complete the project work assigned by your lead.

This offer is subject to your compliance with our terms & conditions of employment and/or association as suggested below, please go through the same and return the signed copy of this letter as a token of acceptance within two (2) working days failing which this offer letter will stand cancelled.

1. You will be required to display professionalism throughout your stay at Access 2 Justice
2. You will be required to sign an Non-Disclosure Agreement as per company terms
3. You are recommended not to take leaves during the internship program, however, under unavoidable circumstances, you shall notify your lead in advance

Our team at Access 2 Justice congratulates you on this new appointment. Please sign the duplicate copy of the offer and return to the **Manager - Human Resources**. At the time of joining, you are requested to submit a copy of your Aadhaar card and your PAN card.

We welcome you to Access 2 Justice and look forward to a mutually beneficial association.

For Access 2 Justice:



Aathira Satish

(Manager, Human Resources)

Access 2 Justice Technologies & Solutions

Date: April 21, 2023

Rakshita K
Sarada Vilas College, Krishnamurthy Puram,
Mysuru, Karnataka 570004

Dear Rakshita K ,

It is our pleasure to formally take you onboard as a **Project Intern – ML Team**, with effect from **01/05/2023** and a monthly stipend of **Rs. 10,000/-** (Rupees Ten Thousand Only) for a period of three months. There will be an additional bonus of up to 50% of your fixed pay (i.e., INR 5000), subject to your contributions and performance during the internship program as evaluated by your project lead. During this program you will be provided with opportunities to contribute to the ongoing projects at Access 2 Justice and/or do the proof-of-concept (POC) on niche technologies. By the end of the program, you are expected to complete the project work assigned by your lead.

This offer is subject to your compliance with our terms & conditions of employment and/or association as suggested below, please go through the same and return the signed copy of this letter as a token of acceptance within two (2) working days failing which this offer letter will stand cancelled.

1. You will be required to display professionalism throughout your stay at Access 2 Justice
2. You will be required to sign an Non-Disclosure Agreement as per company terms
3. You are recommended not to take leaves during the internship program, however, under unavoidable circumstances, you shall notify your lead in advance

Our team at Access 2 Justice congratulates you on this new appointment. Please sign the duplicate copy of the offer and return to the **Manager - Human Resources**. At the time of joining, you are requested to submit a copy of your Aadhaar card and your PAN card.

We welcome you to Access 2 Justice and look forward to a mutually beneficial association.

For Access 2 Justice:



Aathira Satish

(Manager, Human Resources)



Sarada Vilas Educational Institutions (R)
SARADA VILAS COLLEGE

Phone : 0821 - 2332479

Fax : 0821 - 2330221

Krishnamurthypuram, Mysuru - 570 004

(Affiliated to the University of Mysore)

Reaccredited by NAAC with B+grade (CGPA : 2.70)

E-mail : principal@saradavilas.com, Website : www.saradavilas.com

Dr. M. Devika, M.Sc., M. Phil., Ph.D

Principal

Mobile : 9880024483

To,

Mr. Thamarai Selval
VP & Head of Operations
R L Fine Chem Pvt. Ltd.,
Yelahanka New Town
Bangalore - 560 064

13-07-2022

Dear Sir,

Subject: Seeking permission for Industrial Visit for final year M.Sc. Chemistry students

With reference to above context, I intend to bring this to your kind notice that, Sarada Vilas College, Mysuru, a college affiliated to University of Mysore is offering M.Sc. (Chemistry) course since past 09 years. I am happy to inform you that 43 students are studying in final year M.Sc. (Chemistry) in the present academic year in our College and they are interested to visit your esteemed company, R L Fine Chem Pvt. Ltd, Bangalore to enrich their knowledge. I will be grateful if you could permit our students and accompanying four staff members to visit your company and guide them on 16.07.2022. It will be appreciated if you confirm through E-Mail.

Looking forward to your positive reply.

Thanking You.

Industrial Visit done on 16/07/22



Kem
13/7/2022
Dr. Devika M

Principal
Dr. M Devika
M.Sc., M. Phil., Ph.D.
Principal
Sarada Vilas College,
Krishnamurthypuram, Mysuru.



Sarada Vilas Educational Institutions (R)
SARADA VILAS COLLEGE

Phone : 0821 - 2332479

Fax : 0821 - 2330221

Krishnamurthypuram, Mysuru - 570 004

(Affiliated to the University of Mysore)

Reaccredited by NAAC with B+grade (CGPA : 2.70)

E-mail : principal@saradavilas.com, Website : www.saradavilas.com

Dr. M. Devika, M.Sc., M. Phil., Ph.D

Principal

Mobile : 9880024483

To,

Mr. Thamarai Selval
VP & Head of Operations
R L Fine Chem Pvt. Ltd.,
Yelahanka New Town
Bangalore - 560 064

13-07-2022

Dear Sir,

Subject: Seeking permission for Industrial Visit for final year M.Sc. Chemistry students

With reference to above context, I intend to bring this to your kind notice that, Sarada Vilas College, Mysuru, a college affiliated to University of Mysore is offering M.Sc. (Chemistry) course since past 09 years. I am happy to inform you that 48 students are studying in final year M.Sc. (Chemistry) in the present academic year in our College and they are interested to visit your esteemed company, R L Fine Chem Pvt. Ltd, Bangalore to enrich their knowledge. I will be grateful if you could permit our students and accompanying four staff members to visit your company and guide them on 16.07.2022. It will be appreciated if you confirm through E-Mail.

Looking forward to your positive reply.

Thanking You,

Dr. Devika M

Principal

Dr. M Devika

M.Sc., M.Phil., Ph.D.

Principal

Sarada Vilas College,
Krishnamurthypuram, Mysuru.



Sarada Vilas Educational Institution (R)
Post-Graduate Department of Chemistry
Sarada Vilas College
Krishnamurthypuram,
Mysuru – 570004



Industrial visit

An industrial visit to "*RL fine chem Pvt. Ltd*". # 15, KHB industrial Estate,. Yelahanka, Bengaluru was organized by the Post-Graduate department of chemistry, Sarada Vilas College, Mysuru-04.

M.Sc. (Chemistry) final year students and four faculty members, (Dr. Nanjundaswamy G S, Vinod D, Ganesh R and Geethanjali Y.N) visited to *RL fine chem Pvt.Ltd* . Situated at KHB, Industrial Estate, Yelahanka, Bangalore-560064 on 16/07/2022 Saturday.

Students and faculty members left the Sarada Vilas College campus at 5:00 AM and reached the company at 10:00 AM.

After the security check of all the students and staffs were taken into conference hall to give brief introduction, on products manufactured in the Industry and safety measurement to be followed inside the industry by Mr. Murlidharan Manager. The main products manufactured in industry are API (active pharmaceutical ingredients like Amitriptyline hydrochloride, Chlorpromazine hydrochloride, Clomipramine hydrochloride, Doxylamine succinate etc.

. we were divided into two batches and at first we were taken to Solvent loading and unloading area and to storage area there they briefly explained about the storage of chemicals(Raw materials),then to chemical reactors there they explained different types of chemical reactors, like stainless steel , glass layer reactors, and they also explained some of the drying techniques of products obtained and quality test of them and explained the instrumentation of HPLC and GC chromatography technique and also about the dispatch of the product.

Finally we were taken to seminar hall by our guide Mr. Murlidhar and Dr. Shivakumaran, they interacted with students and answered each and every question asked by students.

The industrial visit to *RL fine chem pvt. Ltd* company enriched student knowledge and operating techniques of varieties of instruments and equipments.



Coordinator

Dr. R. Gururaja
Adjunct Professor / Coordinator
Post-Graduate Department of Chemistry
Sarada Vilas College, Mysuru - 575 001

On Fri, 16 Dec 2022 at 9:10 AM, Dinesh Kumar <dinesh@supreempharma.in> wrote:

Dear Madam,

Reforwarding the same for your kind reference.

Best regards,

Dinesh



Supreem Pharmaceuticals Mysore Pvt Ltd
 73,74 & 48P-1, KIADB Industrial Area
 Nanjangud - 571302, India
 Telephone: 08221-224483 & 84
 Email: info@supreempharma.in, dinesh@supreempharma.in
 Website: www.supreempharma.in
 Mobile: +919900596960

----- Forwarded message -----

From: **Dinesh Kumar** <dinesh@supreempharma.in>
 Date: Thu, Dec 15, 2022 at 4:30 PM
 Subject: Fwd: industrial internship
 To: <principal@saradavilas.com>
 Cc: Kalavathi H <kala@supreempharma.in>, HR <hrd@supreempharma.in>

Dear Dr Devika M,

Greetings from Supreem Pharmaceuticals !!

This has reference to the telecon with you today.

We are pleased to offer an internship for 2 students at Supreem Pharmaceuticals Mysore Pvt Ltd, Nanjangud.

The following are the guidelines:

- Letter from College addressed to the Company
- Duration & Period of internship: (Start date & end date) - can be communicated back by email.
- ID Proof of the students along with the college registration number / id number / Total credits assigned.
- The internship / project certificate will be provided only after successful completion of the internship / project and at no point in time will be provided before the completion. Holiday as per company's norms.
- The Students will have to sign the IT Policy and Good Manufacturing Practices of the Company
- Male candidates should come neatly shaven every day (razor shave & not with trimmer). Nail to be trimmed regularly for both male and female candidates
- The Company **will not be providing accommodation and travel**
- Stipend **shall not** be provided during the period of internship / projects undertaken
- **The students will have to get their aprons during the said period**
- Breakfast and lunch will be provided for the students pursuing their internship / projects
- The company shall not be responsible for any accidents / health related issues during the time of internship
- Frequent leaves are a strict "NO"
- Students will have to submit their mobile numbers, regularly accessed personal email id and alternate mobile number for emergency contact.



SARADA VILAS COLLEGE
Krishnamurthy puram, Mysore – 570 004 Karnataka
Affiliated to University of Mysore
Re accredited by NAAC with B+ grade (CGPA: 2.70)



Dr. M Devika, M.Sc., M.Phil., Ph.D

Principal

Mobile: 9880024483

Date: 19-12-2022

To

Dinesh Kumar,

HRD,

Suprem Pharmaceuticals Mysore PvtLtd,

73,74 & 48 P-1 , KIADB Industrial Area ,

Nanjangud-571302.

Dear Sir,

Sub: Industrial Internship for M.Sc. (Chemistry) students.

Ref: E- mail. Received on 15-Dec.2022

With reference to the above, my sincere thanks to you for giving an opportunity to our M.Sc. (Chemistry) students to do internship at your esteem company. We are sending below mentioned

M.Sc.(Chemistry)- III semester students for Internship

1. Shashank Parameshwar Hegde (Reg.No. P01BG21S0007)
2. Mahadevaswamy .K (Reg.No.P01BG21S0020)

I have communicated your instructions to the students and also instructed the students strictly to abide by the rules and regulations of your company during their stay at your esteem company. Looking forward for your early reply regarding preferred date and time of internship.

Thanking you

Truly yours

Principal
Sarada Vilas College
Mysore



#23, 2nd Floor, 5th Cross, Chunchaghatta Main Road, Off Kanakapura Road Metro Station
Bengaluru - 560062

Website: www.vidhathriacademy.in | Email: contact@vidhathriacademy.in

CERTIFICATE

This is to certify that Mr./Ms. NITHIN GS

of the ~~Under-graduate~~ / Post-graduate Department of Chemistry / _____ of

SARADA VILAS COLLEGE Has participated and successfully completed the

Advanced training cum internship program on

"Essentials of Synthesis to Chemical Industry"

conducted by this centre between 1st to 30th June 2023

at M/S ~~Orion Life Sciences~~ / SudhiShubha Chemsynthons Ltd. / Dr. Dalavai Laboratories,

Bengaluru.

The major areas covered being :

- Separation techniques
- Understanding safety in chemical lab
- Planning single step and multi step synthesis
- Execution of the synthesis
- Isolation and characterization principles
- Report writing

Dr. Madhu Ganesh
Founder-Director

Mr. Shivsharan Revoore
Operations Manager





#23, 2nd Floor, 5th Cross, Chunchaghatta Main Road, Off Kanakapura Road Metro Station
Bengaluru - 560062

Website: www.vidhathriacademy.in | Email: contact@vidhathriacademy.in

CERTIFICATE

This is to certify that Mr./Ms. RAHITH M.M.

of the ~~Under-Graduate~~ / Post-graduate Department of Chemistry / _____ of

SARADA VILAS COLLEGE Has participated and successfully completed the

Advanced training cum internship program on

"Essentials of Synthesis to Chemical Industry"

conducted by this centre between 1st to 30th June 2023

at M/S Onium Life Sciences / ~~SudhiShubha Chemsynthons Ltd.~~ / ~~Dr. Balavai Laboratories,~~

Bengaluru.

The major areas covered being :

- Separation techniques
- Understanding safety in chemical lab
- Planning single step and multi step synthesis
- Execution of the synthesis
- Isolation and characterization principles
- Report writing

Dr. Madhu Ganesh
Founder-Director

Mr. Shivsharan Revoore
Operations Manager



CERTIFICATE

This is to certify that Mr./Ms. SHARATH K.P

of the ~~Under-Graduate~~ / Post-graduate Department of Chemistry / _____ of

SARADA VILAS COLLEGE Has participated and successfully completed the

Advanced training cum internship program on

"Essentials of Synthesis to Chemical Industry"

conducted by this centre between 1st to 30th June 2023

at M/S Onium Life Sciences / ~~SudhiShubha-Chemsynthons Ltd.~~ / ~~Dr. Dalavai Laboratories,~~

Bengaluru.

The major areas covered being :

- Separation techniques
- Understanding safety in chemical lab
- Planning single step and multi step synthesis
- Execution of the synthesis
- Isolation and characterization principles
- Report writing

Madhu
Dr. Madhu Ganesh
Founder-Director

Shivsharan
Mr. Shivsharan Revoore
Operations Manager





#23, 2nd Floor, 5th Cross, Chunchaghatta Main Road, Off Kanakapura Road Metro Station
Bengaluru - 560062

Website: www.vidhathriacademy.in | Email: contact@vidhathriacademy.in

CERTIFICATE

This is to certify that Mr./Ms. SINDHU R. JOIS

of the ~~Under-Graduate~~ / Post-graduate Department of Chemistry / _____ of

SARADA VILAS COLLEGE Has participated and successfully completed the

Advanced training cum internship program on

"Essentials of Synthesis to Chemical Industry"

conducted by this centre between 1st to 30th June 2023

at M/S ~~Onium Life Sciences / SudhiShubha Chemsynthons Ltd.~~ / Dr. Dalavai Laboratories,

Bengaluru.

The major areas covered being :

- Separation techniques
- Understanding safety in chemical lab
- Planning single step and multi step synthesis
- Execution of the synthesis
- Isolation and characterization principles
- Report writing

Dr. Madhu Ganesh
Founder-Director

Mr. Shivsharan Revoore
Operations Manager





#23, 2nd Floor, 5th Cross, Chunchaghatta Main Road, Off Kanakapura Road Metro Station
Bengaluru - 560062

Website: www.vidhathriacademy.in | Email: contact@vidhathriacademy.in

CERTIFICATE

This is to certify that ~~Mr./Ms.~~ **SHIVARANJINI A.**

of the ~~Under-Graduate~~ / Post-graduate Department of Chemistry /-.....of

SARADA VILAS COLLEGE Has participated and successfully completed the

Advanced training cum internship program on

"Essentials of Synthesis to Chemical Industry"

conducted by this centre between **1st to 30th June 2023**

at ~~M/S Orionum Life Sciences~~ / **SudhiShubha Chemsynthons Ltd.** / ~~Dr. Dalavai Laboratories,~~
Bengaluru.

The major areas covered being :

- Separation techniques
- Understanding safety in chemical lab
- Planning single step and multi step synthesis
- Execution of the synthesis
- Isolation and characterization principles
- Report writing

Dr. Madhu Ganesh
Founder-Director

Mr. Shivsharan Revoore
Operations Manager





#23, 2nd Floor, 5th Cross, Chunchaghatta Main Road, Off Kanakapura Road Metro Station
Bengaluru - 560062

Website: www.vidhathriacademy.in | Email: contact@vidhathriacademy.in

CERTIFICATE

This is to certify that **Mr./Ms.** SHALINI. K.P.

of the ~~Under-Graduate~~ / Post-graduate Department of Chemistry / _____ of

SARADA VILAS COLLEGE Has participated and successfully completed the

Advanced training cum internship program on

"Essentials of Synthesis to Chemical Industry"

conducted by this centre between 1st to 30th June 2023

at ~~M/S Unium Life Sciences / SudhiShubha Chemsynthons Ltd.~~ / Dr. Dalavai Laboratories,

Bengaluru.

The major areas covered being :

- Separation techniques
- Understanding safety in chemical lab
- Planning single step and multi step synthesis
- Execution of the synthesis
- Isolation and characterization principles
- Report writing



Dr. Madhu Ganesh
Founder-Director



Mr. Shivsharan Revoore
Operations Manager





#23, 2nd Floor, 5th Cross, Chunchaghatta Main Road, Off Kanakapura Road Metro Station
Bengaluru - 560062

Website: www.vidhathriacademy.in | Email: contact@vidhathriacademy.in

CERTIFICATE

This is to certify that Mr./Ms. ABHILASH. R.

of the ~~Under-Graduate~~ / Post-graduate Department of Chemistry / _____ of

SARADA VILAS COLLEGE Has participated and successfully completed the

Advanced training cum internship program on

"Essentials of Synthesis to Chemical Industry"

conducted by this centre between 1st to 30th June 2023

at ~~M/S Onium Life Sciences / SudhiShubha Chemsynthons Ltd.~~ / Dr. Dalavai Laboratories,

Bengaluru.

The major areas covered being :

- Separation techniques
- Understanding safety in chemical lab
- Planning single step and multi step synthesis
- Execution of the synthesis
- Isolation and characterization principles
- Report writing

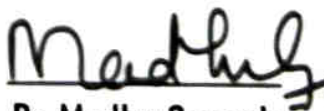

Dr. Madhu Ganesh
Founder-Director



Mr. Shivsharan Revoore
Operations Manager





#23, 2nd Floor, 5th Cross, Chunchaghatta Main Road, Off Kanakapura Road Metro Station
Bengaluru - 560062

Website: www.vidhathriacademy.in | Email: contact@vidhathriacademy.in

CERTIFICATE

This is to certify that Mr./Ms. SAJJAN . L. GOWDA
of the ~~Under Graduate~~ / Post-graduate Department of Chemistry / _____ of
SARADA VILAS COLLEGE Has participated and successfully completed the
Advanced training cum internship program on
"Essentials of Synthesis to Chemical Industry"
conducted by this centre between 1st to 30th June 2023
at M/S Onium Life Sciences / ~~Sudhi Shubha Chemsynthons Ltd.~~ / ~~Dr. Dalavai Laboratories,~~
Bengaluru.

The major areas covered being :

- Separation techniques
- Understanding safety in chemical lab
- Planning single step and multi step synthesis
- Execution of the synthesis
- Isolation and characterization principles
- Report writing

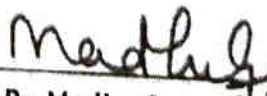
Dr. Madhu Ganesh
Founder-Director

Mr. Shivsharan Revooore
Operations Manager





#23, 2nd Floor, 5th Cross, Chunchaghatta Main Road, Off Kanakapura Road Metro Station
Bengaluru - 560062

Website: www.vidhathriacademy.in | Email: contact@vidhathriacademy.in

CERTIFICATE

This is to certify that **Mr./Ms. RAKSHITHA.S.**

of the ~~Under Graduate~~ / Post-graduate Department of Chemistry / _____ of

~~SARADAYILAS COLLEGE~~ Has participated and successfully completed the

Advanced training cum internship program on

"Essentials of Synthesis to Chemical Industry"

conducted by this centre between 1st to 30th June 2023

at M/S ~~Omium Life Sciences~~ / SudhiShubha Chemsynthons Ltd. / ~~Dr. Dalavai Laboratories~~,

Bengaluru.

The major areas covered being :

- Separation techniques
- Understanding safety in chemical lab
- Planning single step and multi step synthesis
- Execution of the synthesis
- Isolation and characterization principles
- Report writing

Dr. Madhu Ganesh
Founder-Director

Mr. Shivsharan Revoore
Operations Manager





#23, 2nd Floor, 5th Cross, Chunchaghatta Main Road, Off Kanakapura Road Metro Station
Bengaluru - 560062

Website: www.vidhathriacademy.in | Email: contact@vidhathriacademy.in

CERTIFICATE

This is to certify that Mr./Ms. PAVAN. C.K

of the ~~Under-Graduate~~ / Post-graduate Department of Chemistry / _____ of

SARADA VILAS COLLEGE Has participated and successfully completed the

Advanced training cum internship program on

"Essentials of Synthesis to Chemical Industry"

conducted by this centre between 1st to 30th June 2023

at M/S Onium Life Sciences / ~~SudhiShubha Chemsynthons Ltd.~~ / ~~Dr. Dalavai Laboratories,~~

Bengaluru.

The major areas covered being :

- Separation techniques
- Understanding safety in chemical lab
- Planning single step and multi step synthesis
- Execution of the synthesis
- Isolation and characterization principles
- Report writing

Dr. Madhu Ganesh
Founder-Director

Mr. Shivsharan Revoore
Operations Manager





#23, 2nd Floor, 5th Cross, Chunchaghatta Main Road, Off Kanakapura Road Metro Station
Bengaluru - 560062

Website: www.vidhathriacademy.in | Email: contact@vidhathriacademy.in

CERTIFICATE

This is to certify that Mr./Ms. MANASA.H.M.

of the ~~Under-Graduate~~ / Post-graduate Department of Chemistry / _____ of

~~SARADA VILAS COLLEGE~~ Has participated and successfully completed the

Advanced training cum internship program on

"Essentials of Synthesis to Chemical Industry"

conducted by this centre between 1st to 30th June 2023

at M/S ~~Onium Life Sciences~~ / SudhiShubha Chemsynthons Ltd. / ~~Dr. Dalavai Laboratories~~,
Bengaluru.

The major areas covered being :

- Separation techniques
- Understanding safety in chemical lab
- Planning single step and multi step synthesis
- Execution of the synthesis
- Isolation and characterization principles
- Report writing

Dr. Madhu Ganesh
Founder-Director

Mr. Shivsharan Revoore
Operations Manager





#23, 2nd Floor, 5th Cross, Chunchaghatta Main Road, Off Kanakapura Road Metro Station
Bengaluru - 560062

Website: www.vidhathriacademy.in | Email: contact@vidhathriacademy.in

CERTIFICATE

This is to certify that Mr./Ms. HARSHITHA .OK
of the ~~Under-Graduate~~ / Post-graduate Department of Chemistry / _____ of
SARADA VILAS COLLEGE Has participated and successfully completed the

Advanced training cum internship program on

"Essentials of Synthesis to Chemical Industry"

conducted by this centre between 1st to 30th June 2023

at M/S ~~Orion Life Sciences~~ / ~~SudhiShubha Chemsynthons Ltd.~~ / Dr. Dalavai Laboratories,
Bengaluru.

The major areas covered being :

- Separation techniques
- Understanding safety in chemical lab
- Planning single step and multi step synthesis
- Execution of the synthesis
- Isolation and characterization principles
- Report writing

Dr. Madhu Ganesh
Founder-Director

Mr. Shivsharan Revoore
Operations Manager





#23, 2nd Floor, 5th Cross, Chunchaghatta Main Road, Off Kanakapura Road Metro Station
Bengaluru - 560062

Website: www.vidhathriacademy.in | Email: contact@vidhathriacademy.in

CERTIFICATE

This is to certify that Mr./Ms. CHAITHANYA, N.R.
of the ~~Under Graduate~~ / Post-graduate Department of Chemistry / of
SARADA VILAS COLLEGE Has participated and successfully completed the
Advanced training cum internship program on
"Essentials of Synthesis to Chemical Industry"
conducted by this centre between 1st to 30th June 2023
at M/S ~~Orionum Life Sciences~~ / SudhiShubha Chemsynthons Ltd. / ~~Dr. Dalavai Laboratories~~,
Bengaluru.

The major areas covered being :

- Separation techniques
- Understanding safety in chemical lab
- Planning single step and multi step synthesis
- Execution of the synthesis
- Isolation and characterization principles
- Report writing

Madhu
Dr. Madhu Ganesh
Founder-Director

Shivsharan
Mr. Shivsharan Revoore
Operations Manager





ಶಾರದಾ ವಿಲಾಸ ಕಾಲೇಜು

ಕೃಷ್ಣಮೂರ್ತಿಪುರಂ, ಮೈಸೂರು - 570 004

ಮೈಸೂರು ವಿಶ್ವವಿದ್ಯಾನಿಲಯದಿಂದ ಮಾನ್ಯತೆ ಪಡೆದಿದೆ

NAAC ನಿಂದ B+ ಗ್ರೇಡ್ (CGPA: 2.70) ಮರುಮೌಲ್ಯಾಂಕನ ಪಡೆದಿದೆ



ಪ್ರೊ. ಡಾ. ಎಂ. ದೇವಿಕಾ, ಎಂ.ಎಸ್ಸಿ, ಎಂ.ಫಿಲ್, ಪಿ.ಹೆಚ್‌ಡಿ
ಪ್ರಾಂಶುಪಾಲರು

ಮೊಬೈಲ್: 9880024483

ಸಂಖ್ಯೆ: ಎಸ್‌ವಿಸಿ/ಬಸ್ ರಿಯಾಯಿತಿ/39 /2023-24

ದಿನಾಂಕ : 03-06-2023

ಗೆ,

ವಿಭಾಗೀಯ ಸಂಚಲನಾಧಿಕಾರಿಗಳು
ಮೈಸೂರು ಕೇಂದ್ರ ಬಸ್ ನಿಲ್ದಾಣ
ಮೈಸೂರು ಗ್ರಾಮಾಂತರ ವಿಭಾಗ
ಮೈಸೂರು.

ಮಾನ್ಯರೆ,

ವಿಷಯ : ಶೈಕ್ಷಣಿಕ ಪ್ರವಾಸಕ್ಕೆ ವಿದ್ಯಾರ್ಥಿಗಳಿಗೆ ರಾಜಹಂಸ ಬಸ್ಸನ್ನು ನೀಡುವ ಬಗ್ಗೆ.

ಸೂಚಿತ ವಿಷಯಕ್ಕೆ ಸಂಬಂಧಿಸಿದಂತೆ ದಿನಾಂಕ 08-06-2023 ರಿಂದ 11-06-2023 ರಂದು ನಮ್ಮ ಕಾಲೇಜಿನ 35 ಸ್ನಾತಕೋತ್ತರ ಪದವಿ ವಿದ್ಯಾರ್ಥಿಗಳನ್ನು ತಮಿಳುನಾಡಿನ ಚೆನ್ನೈನಲ್ಲಿರುವ IIT ಮದ್ರಾಸ್‌ಗೆ ಶೈಕ್ಷಣಿಕ ಪ್ರವಾಸಕ್ಕೆ ಕರೆದುಕೊಂಡು ಹೋಗುತ್ತಿರುವುದರಿಂದ ವಿದ್ಯಾರ್ಥಿಗಳಿಗೆ ರಾಜಹಂಸ ಬಸ್ಸನ್ನು ರಿಯಾಯಿತಿ ದರದಲ್ಲಿ ನೀಡಬೇಕೆಂದು ಈ ಮೂಲಕ ವಿನಂತಿಸಿಕೊಳ್ಳುತ್ತೇನೆ. ಈ ಪತ್ರದೊಂದಿಗೆ ವಿದ್ಯಾರ್ಥಿಗಳ ಮತ್ತು ಜೊತೆಯಲ್ಲಿ ಬರುವ ನಾಲ್ವರು ಪ್ರಾಧ್ಯಾಪಕರ ಹೆಸರಿನ ಪಟ್ಟಿಯನ್ನು ಲಗತ್ತಿಸಲಾಗಿದೆ.

ವಂದನೆಗಳೊಂದಿಗೆ

ತಮ್ಮ ವಿಶ್ವಾಸಿ,

Dr. M. Devika
M.Sc., M.Phil., Ph.D.
Principal
Sarada Vilas College
Krishnamurthy Road, Mysore

Sarada Vilas College, Krishnamurthypuram, Mysuru-04

Post-Graduate department of Chemistry

Final year M.Sc. (Chemistry) - 2022-23

List of students:

SI. No.	Name of the student	Contact No.	Email ID
1.	Abhilash R	7090118855	abhidhoni117@gmail.com
2.	Aishwarya D	9353947475	aishwarya.d7475@gmail.com
3.	Aishwarya K Acharya	9741777937	akacharya.0002@gmail.com
4.	Ashika H.S	9902927433	ashikahs14@gmail.com
5.	Ashwini S.S	8722577127	ashwini gangadikara@gmail.com
6.	Chaithanya N B	6360404568	chaithanyanb2717@gmail.com
7.	Darshini E	9900219072	Darshiniyb182438@gmail.com
8.	Harsha S. R	8861061316	harshasr738@gmail.com
9.	Harsha kumar S	7848805894	rockingharshal5@gmail.com
10.	Harshitha O K	7411040751	Harshithaharshagowda88@gmail.com
11.	Keerthana R	8088589142	Keeruputa8@gmail.com
12.	Madhumalini R	8088283380	Madhurajashekar1983@gmail.com
13.	Mahadevaswamy K	6361798163	Mahadevaswamyk941@gmail.com
14.	Manasa H M	9008256395	manasamanjunath403@gmail.com
15.	Nisha C.L	8861191425	Nishaclnishacl043@gmail.com
16.	Nithin. C.S	8197777926	Nithincsaradya6590@gmail.com
17.	Pallavi R	7090194350	pallavipallavi1580@gmail.com
18.	Pavan. C. K	9731023698	Pavanack9@gmail.com
19.	Pradyumna S	6360743783	9535653056ps@gmail.com
20.	Pramatha M	9380459439	pramatham2001@gmail.com
21.	Preethu N K	8088841264	Preethunk14@gmail.com
22.	Priya C K	6364119262	Priyack12899@gmail.com
23.	Purushottama H.M	8970545005	purushothamahmctet@gmail.com
24.	Rakshitha S	9901040686	rakshithas2992000@gmail.com
25.	Revanth M N	6363530968	revanthmn.hnp@gmail.com
26.	Rohith M M	7411103484	rohithgowda01978@gmail.com
27.	Sahana B	7338464264	sahanabkote@gmail.com
28.	Sajjan L Gowda	9380880206	sajjanlgowda@gmail.com
29.	Shalini K.P	8951501530	Shalinishalu2556@gmail.com
30.	Sharat K P	9019593568	Sharathkp5@gmail.com
31.	Shashank param-eshwara Hegde	6361303436	Shashankahegde907@gmail.com
32.	Shivaranjani. A	9538591255	Ranjushivaranjini16@gmail.com
33.	Sindhu R Jois	8073897917	Sindhurjois24@gmail.com
34.	Tejas	6362648466	Tejasnaveen.23@gmail.com
35.	Varsha A M	7337662343	Varshanahesh1964@gmail.com

List of faculties:

Sl.No.	Name	Designation	Phone no.
1	Dr.Nanjundaswamy G S	Assistant Professor	8851824981
2	Ms.Geetha S	Assistant Professor	8217722462
3	Mr.Vinod D	Assistant Professor	7353448718
4	Mr.Adharsh M	Assistant Professor	9845683801

Signature of the Principal

M.Sc., M.Phil., Ph.D.
Principal
Sarada Vilas College,
Krishnamurthypuram, Mysuru



saifhead@iitm.ac.in



- Compose
- Mail
- Inbox 222
- Starred
- Snoozed
- Important
- Drafts 207
- Categories
- Social 2,284
- Updates 87
- Forums 3
- Promotions 3,204
- More
- Labels
- More

Confirmation for your students visit on 09.06.2023 -reg

Inbox

O Office SAIF
to me, Head

Dear Sir,

Sub: Confirmation for your students visit on 09.06.2023 @10.00AM -reg
Ref: Your online booking request & e-mail dated: 08.05.2023 -reg

As, requested by you through online booking, for students visit & E-mail dated: 08.05.2023, It is to inform you th

The details of the contact person should be send to us, for further correspondence.

Please send the visiting faculty & students name details to us.

Please give prior information to our SAIF office before reaching the IITM campus main Entrance gate.

Adhere to the Covid-19 precautionary protocols, Students & members accompanying them should be fully vacci

With regards,

A.Nandakumar
सेक/ SAIF Office
आईआई टी मद्रास/IITMadras,
चेन्नई/Chennai
फोन/Phone- 044- 22574935
ई-मेल/E-Mail - saif@iitm.ac.in

!!! Be Different & Make a Difference !!!

Contribute to the Environment: Please do not print this mail unless and until very necessary.
Think before you print...

Reply

Reply all

Forward



SOPHISTICATED ANALYTICAL INSTRUMENT FACILITY

परिष्कृत विश्लेषणात्मक उपकरण सुविधा

Indian Institute of Technology Madras

भारतीय प्रौद्योगिकी संस्थान मद्रास

Chennai – 600 036, INDIA

चेन्नई - 600 036, भारत

Friday, June 09, 2023

To whomsoever it may concerned

This is to certify that the following M.Sc Chemistry students & faculty members from Department of Chemistry, Sarada Vilas College, Mysuru, Karnataka, had visited our SAIF facilities, IITM on 09-06-2023
Faculty:- Dr. Gururaja. R, Dr. Nanjundaswamy. G. S, Ms. Geetha. S, Mr. Vinod D and Mr. Adharsh. M

Sl.No	Name of The Students
1.	Abhilash. R
2.	Aishwarya. D
3.	Aishwarya K Acharya
4.	Ashika. H. S
5.	Ashwini. S. S
6.	Chaithanya. N. B
7.	Darshini. E
8.	Harsha. S. R
9.	Harsha Kumar. S
10.	Harshitha. O. K
11.	Keerthana. R
12.	Mahadevaswamy. K
13.	Manasa. H. M
14.	Nisha. C. L.
15.	Nithin. C. S
16.	Pallavi. R
17.	Pavan. C. K
18.	Pradyumna. S
19.	Pramatha. M
20.	Preethu. N. K
21.	Priya. C. K

J. N. S. 9/6/23
SAIF
IIT MADRAS

22.	Purushottama. H. M
23.	Rakshitha. S
24.	Revanth. M. N
25.	Rohith. M. M
26.	Sahana. B
27.	Sajjan. L. Gowda
28.	Shalini. K.P
29.	Sharat. K.p
30.	Shashank Param- Eshwara Hedge
31.	Shivaranjani. A
32.	Sindhu. R. Jois
33.	Tejas
34.	Varsha. A. M

A. No. 9/16/23





SOPHISTICATED ANALYTICAL INSTRUMENT FACILITY

INDIAN INSTITUTE OF TECHNOLOGY MADRAS

RefNo: 08/05/2023071807

Date: 23/05/08

Request for Permission to visit Facilities in SAIF

Name	Dr R Gururaja	Designation	Coordinator
Address	Post-Graduate department of chemistry, Sarada Vilas College, Mysuru	City / Town	Mysuru
State	Karnataka	Pincode	570004
Email	dr.gururaja@gmail.com	Phone Number	9448957959
Office Number	08212332479	Requested date of visit*	2023-06-09

In case of lab visits by group of students/faculty/employees from Industries/R&D labs, kindly provide the number of visitors and their designation (eg. Student/faculty/staff etc) and the labs they want to visit in particular. This is needed to obtain security clearance. A basic knowledge of the use/application or principle of working of the instrument will help you understand things better in the available time. Kindly note that the size of the laboratories restricts us to 25 visitors at a time.

Total number of visitors	25	No of Students	21
No of staff	4	Any other request	nil

It is mandatory that a prior written / e.mail confirmation is obtained from the Head of SAIF before you visit. Requisition forms are to be formally approved and signed by the Head of the Department or Guide or a senior official of your institution/company.

Signature with seal

Dr. R. Gururaja

* Normally all visits to SAIF are arranged in the afternoon from 1400hrs to 1700hrs (2pm-5pm). In special circumstances a visit can be arranged in the morning (1000hrs to 1300hrs) for which a request has to be marked to saif@iitm.ac.in. Kindly make sure that the requested date is a working day for IIT Madras.

Print

A
PROJECT REPORT
On

An Analytical Study on the Service Methods Adopted by MYMUL and its
Influence on Buying Behaviour of Consumers.

Submitted by
Ramya T
Reg. No: P01BG21C0009

Internal Guide

Dr. Jyothi A N
Department of Commerce
PG Centre-M.com
Sarada Vilas College, Mysuru.

External Guide

Mrs. Shwetha
Assistant Manager
MYMUL.

Submitted to
University of Mysore

In partial fulfilment of award of post Graduate Degree in Commerce – M.Com
Department of commerce and Business Administration,
PG Centre – M.com
Sarada Vilas College, Mysuru



SARADA VILAS EDUCATIONAL INSTITUTIONS (Regd.)

SARADA VILAS COLLEGE

Krishnamurthypuram, Mysore - 570 004 Karnataka

Affiliated to University of Mysore

Re accredited by NAAC with B+ grade (CGPA: 2.70)



Date : 05/09/2023

Certification

This is to certify that Ms. RAMYA T (Reg. No. P01BG21C0009) is a bonafide student of PG Centre - M.Com, Sarada Vilas College, studying M.Com final year in the academic year 2022-2023. As a part of her final examination M.Com she has prepared a project report on **"An Analytical Study on the Service Methods Adopted by MYMUL and its Influence on Buying Behaviour of Consumers"**, under the guidance of Dr. Jyothi A N, Assistant Professor, PG Centre - M.Com, Sarada Vilas College, Mysuru. I certify that, this project work is her original work and not presented to any other University / Institution for award of any Degree/Diploma.

Dean 
Commerce and Busi. Admn.
Sarada Vilas College
Mysuru-570 004
Dean

Principal

Dr. M Devika
M.Sc., M.Phil., Ph.D.
Principal
Sarada Vilas College,
Krishnamurthypuram, Mysuru

A
Project Report

On

“A Study on the Consumer Buying Experience of Electric Two Wheelers -
With Special References to the Consumer of 3v Multi Ventures”.

Submitted by
Sachin K G
Reg. No: P01BG21C0014

Internal Guide

Dr. Jyothi A.N
Assistant professor
P G Center-M.com
Department of Commerce
Sarada Vilas College, Mysuru

External Guide

Mr. Sudheer G.R
General Manager
3v Multi Ventures
Mysuru

Submitted to

University of Mysore
In partial fulfilment of Post Graduation Degree in Commerce- M.com
Department of Commerce and Business Administration
P G Centre- M.com
Sarada Vilas College, Mysuru



SARADA VILAS EDUCATIONAL INSTITUTIONS (Regd.)

SARADA VILAS COLLEGE

Krishnamurthypuram, Mysore – 570 004 Karnataka

Affiliated to University of Mysore

Re accredited by NAAC with B+ grade (CGPA: 2.70)



Date : 5-9-2023

Certification

This is to certify that Mr. SACHIN K G (Reg. No. P01BG21C0014) is a bonafide student of PG Centre - M.Com, Sarada Vilas College, studying M.Com final year in the academic year 2022-2023. As a part of his final examination M.Com he has prepared a project report on "A Study on the Consumer Buying Experience of Electric Two Wheeler - With Special reference to the Consumer of 3v Multi Ventures", under the guidance of Dr. Jyothi A N, Assistant Professor, PG Centre - M.Com, Sarada Vilas College, Mysuru. I certify that, this project work is his original work and not presented to any other University / Institution for award of any Degree/Diploma.

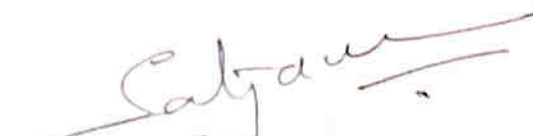
Dean
Commerce and Bus. Adm.
Sarada Vilas College
Mysuru-570 004

Principal
Dr. M Devika
M.Sc., M.Phil., Ph.D.
Principal
Sarada Vilas College,
Krishnamurthypuram, Mysuru

CERTIFICATE

This is to certify that Mr. SACHIN K.G. (Reg. No. P01BG21C0014) IV Semester M. Com student of Sharada Vilas College, PG Centre, Mysore University has undergone the project work in Financial Statement. He has completed his project from in "A STUDY THE CONSUMER BUYING EXPERIENCE OF ELECTRIC TWO WHEELERS -WITH SPECIAL REFERENCE OF CONSUMER OF 3V MULTI VENTURES". successfully under the guidance of Mr. Sudheer G.R General Manager, 3v Multi Ventures Mysuru We wish him all the success in his future endeavour.

Place: *Mysore*
Date: *8/8/23*

With Regards

For 3V Multi Ventures LLP

Authorized Signatory

UNIVERSITY OF MYSORE



Project Report

“AN ANALYSIS OF FINANCIAL STATEMENT OF THE
MAYABANDAR DOORS LIMITED, BANNUR ROAD, MYSORE ”

Submitted by

BHOOMIKA M R

Reg. No : P01BG21C0047

Internal Guide

Dr. Jyothi A N

Assistant Professor

Department of Commerce

P.G Centre – M.COM

Sarada Vilas College, Mysore

External Guide

Smt. Sharmila

Accountant

Mayabandar Doors Limited,

Bannur Road, Mysore

Submitted to

University of Mysore

In partial fulfilment of award of post Graduate Degree in Commerce (M.Com)

Department of Commerce P.G Centre – M.com

Sarada Vilas College, Mysore

Phone: 0821-2332479, Fax: 0821-2330221

E- mail: principal@saradavilas.com

website: www.saradavilas.com



SARADA VILAS EDUCATIONAL INSTITUTIONS (Regd.)

SARADA VILAS COLLEGE

Krishnamurthypuram, Mysore – 570 004 Karnataka

Affiliated to University of Mysore

Re accredited by NAAC with B+ grade (CGPA: 2.70)



Date : 05/09/2023

Certification

This is to certify that Ms. BHOOMIKA M R (Reg. No. P01BG21C0047) is a bonafide student of PG Centre - M.Com, Sarada Vilas College, studying M.Com final year in the academic year 2022-2023. As a part of her final examination M.Com she has prepared a project report on "An Analysis of Financial Statement of the Mayabandar Doors Limited, Bannur Road, Mysuru", under the guidance of Dr. Jyothi A N, Assistant Professor, PG Centre - M.Com, Sarada Vilas College, Mysuru. I certify that, this project work is her original work and not presented to any other University / Institution for award of any Degree/Diploma.

Dean
Commerce and Busi. Admn.
Sarada Vilas College
Mysuru-570 004

Principal
Dr. M Devika
M.Sc, M.Phil, Ph.D.
Principal
Sarada Vilas College,
Krishnamurthypuram, Mysuru

MAYABANDAR DOORS LTD.

(Manufacturers of : Quality Flush Doors, Moulded Panel Doors,
Door Frames, Window Frames, Window & Door Shutters & Finger Joined Frames & Shutters)
Factory, Regd. Office : Sy. No. 92/3, 96, 97, Bannur Road, Bhugathagahally, Mysuru - 570 010

Date: 28.07.2023

CERTIFICATE

This is to certify that Ms. Bhoomika.M.R (Reg No.PO1BG21C0047)

Studying M.Com in Sarada Vilas College, Mysore has done

" Project Work" from 01.04.2023 to 29.05.2023 in our Unit successfully.

We wish her all the very best for her future endeavours.

For MAYABANDAR DOORS LIMITED,

For Mayabandar Doors Ltd.,

Authorised signatory

Authorised signatory

Project Report

“ A STUDY ON CUSTOMER PREFERENCE TOWARDS HYUNDAI – 4
WHEELER PRODUCTS. – A CASE STUDY OF STAR HYUNDAI
SHOWROOM HUNSUR.”

Submitted by

RASHMI PK

Reg.No : P01BG21C0039

Internal Guide

Dr. JYOTHI AN

Head of the department

Department of Commerce

P.G Centre – M. Com

Saradavilas College, Mysuru

External Guide

Mr. BOPANNA

Manager

Star Hyundai showroom

HUNSUR

Submitted To

University of Mysuru

In partial fulfillment of award of post Graduate Degree in Commerce (M. Com)

Department of Commerce P G Centre – M. Com

Sarada Vilas College, Mysuru



SARADA VILAS EDUCATIONAL INSTITUTIONS (Regd.)

SARADA VILAS COLLEGE

Krishnamurthypuram, Mysore - 570 004 Karnataka

Affiliated to University of Mysore

Re accredited by NAAC with B+ grade (CGPA: 2.70)



Date :

Certification

This is to certify that Ms. RASHMI P K (Reg. No. P01BG21C0039) is a bonafide student of PG Centre - M.Com, Sarada Vilas College, studying M.Com final year in the academic year 2022-2023. As a part of her final examination M.Com she has prepared a project report on **"A Study on Customer Preference towards Hyundai - 4 Wheeler Products - A Case Study of Star Hyundai Showroom, Hunsur"**, under the guidance of Dr. Jyothi A N, Assistant Professor, PG Centre - M.Com, Sarada Vilas College, Mysuru. I certify that, this project work is her original work and not presented to any other University / Institution for award of any Degree/Diploma.

Dean
Commerce and Busi. Admn.
Sarada Vilas College
Mysuru-570 004

Principal
Dr. M Devika
M.Sc., M.Phil., Ph.D.
Principal
Sarada Vilas College,
Krishnamurthypuram, Mysuru

CERTIFICATE

This is to certify that Ms. RASHMI PK (Reg No PO1BG21C0039) IV Semester M.COM Student of SARADA VILAS college, PG Centre, University of Mysore has undergone the project work on Star Hyundai HUNSUR. She has Completed her project from 01.03 2023 to 30.06.2023 on " A Study on customer preference towards Hyundai – 4 wheeler products . – A case study Of Star Hyundai show room HUNSUR." Successfully under the Guidance of Mr. Monish Proprietor for Sales, HUNSUR. We wish her all the Success in her future Endeavour.

Place : HUNSUR

Date: 05/09/2023

P.R. AUTO AGENCY PRIVATE LIMITED
L-9, Industrial Estate,
Bypass, B.M Road,
Hunsur, Mysore

With Regards



A
Project Report
on
DIGITAL MARKETING:-STATUS IN PUMA FACTORY OUTLET
Mysore

Submitted by
LIKHITHA

Reg. No: P01BG21C0001

Internal Guide

Dr. Jyothi A N
Assistant Professor
Department of Commerce
P. G Centre- M. Com
Sarada Vilas College, Mysore

External Guide

Nagendra
Manager
Puma factory outlet
Mysore

Submitted To
University of Mysore

In partial fulfillment of award of Post Graduate Degree in Commerce - M. Com

Department of Commerce P.G Centre-M.com

Sarada Vilas College, Mysore.



SARADA VILAS EDUCATIONAL INSTITUTIONS (Regd.)

SARADA VILAS COLLEGE

Krishnamurthypuram, Mysore - 570 004 Karnataka

Affiliated to University of Mysore

Re-accredited by NAAC, with B+ grade (CGPA: 2.70)



Date : 5/9/23

Certification

This is to certify that Ms. LIKHITHA (Reg. No. P01BG21C0001) is a bonafide student of PG Centre - M.Com, Sarada Vilas College, studying M.Com final year in the academic year 2022-2023. As a part of her final examination M.Com she has prepared a project report on "Digital Marketing:- Status In Puma Factory Outlet", under the guidance of Dr. Jyothi A N, Assistant Professor, PG Centre - M.Com, Sarada Vilas College, Mysuru. I certify that, this project work is her original work and not presented to any other University / Institution for award of any Degree/Diploma.

Dean

Principal
Dr. M. Devika
Principal
Sarada Vilas College
Krishnamurthypuram, Mysore



PUMA FACTORY OUTLET

Vogue Clothing, No 02, Udayaravi Road,

Kuvempunagar, Mysuru – 570023

CERTIFICATE

This is to certify that **Ms. Likhitha (reg. no PO1BG21C0001)** IV semester M.Com Student of Sarada Vilas College, PG Centre, Mysore, affiliated to University of Mysore has undergone the project work on

"Digital marketing - status in puma factory outlet".

She has successfully worked under my guidance.

We wish her all the success in her future endeavor.

**Puma Factory Outlet
VOGUE CLOTHING
2, RJR Enclave, Near Pramathi School,
Udayaravi Road, Kuvempunagar, Mysore-21.
GSTIN : 29AACFV2886R1Z4
For Puma Factory outlet**

Nagendra
11/08/23

Manager

Place: Mysuru

Project report

A STUDY ON CUSTOMER SATISFACTION TOWARDS THE PRODUCT OF
KARNATAKA SILK INDUSTRIES CORPORATION LIMITED MYSORE

Submitted by

SPOORTHI L N

Reg No:P01BG21C0041

Internal guide

Dr.jyothi A N

Department of commerce

P.G centre-M.com

Saradavilacollege,mysore

External guide

Department officers

KSIC Mysore

Submitted to

University of Mysore

In partial fulfillment of award of post graduate degree in commerce (M.COM)

Department of commerce P.G centre-M.COM

Phone: 0821-2332479, Fax: 0821-2330221

E- mail: principal@saradavilas.com

website: www.saradavilas.com



SARADA VILAS EDUCATIONAL INSTITUTIONS (Regd.)

SARADA VILAS COLLEGE

Krishnamurthypuram, Mysore – 570 004 Karnataka

Affiliated to University of Mysore

Re accredited by NAAC with B+ grade (CGPA: 2.70)



Date : 5/9/2023

Certification

This is to certify that Ms. SPOORTHI L N (Reg. No. P01BG21C0041) is a bonafide student of PG Centre - M.Com, Sarada Vilas College, studying M.Com final year in the academic year 2022-2023. As a part of her final examination M.Com she has prepared a project report on " **A Study on Customer Satisfaction towards the Product of Karnataka Silk Industries Corporation Limited, Mysore**", under the guidance of Dr. Jyothi A N, Assistant Professor, PG Centre - M.Com, Sarada Vilas College, Mysuru. I certify that, this project work is her original work and not presented to any other University / Institution for award of any Degree/Diploma.

Dean
Commerce and Busi. Admn.
Sarada Vilas College
Mysuru-570 004

Principal
Dr. M Devika
M.Sc., M.Phil., Ph.D.
Principal
Sarada Vilas College,
Krishnamurthypuram, Mysuru



AN ISO 9001-2015 AND 14001 - 2015 CERTIFIED COMPANY

Karnataka Silk Industries Corporation Ltd.,

(A Government of Karnataka Undertaking)

Phone No. 2481803, 2485303 Fax : 0821 - 2483544, E-mail : gmksic @dataone.in

NO.SWF/PROJ/ ⁵⁴⁵⁵ /2023-24

DATE :04/09/2023

: CERTIFICATE :

This is to certify that Ms.Spoorthi L.N., (Reg.No.P01BG21C0041) who is studying M.Com at Sharada Vilas College, Mysore , has successfully completed the Project on " A STUDY ON CUSTOMER SATISFACTION TOWARDS THE PRODUCT OF KARNATAKA SILK INDUSTRIES CORPORATION LTD, MYSORE" at KSIC. Unit: Silk Weaving Factory, Mysore from 05/06/2023 to 15/07/2023 under the guidance of Officers of SWF, Mysore.

We certify that the above student has carried out all the necessary work in connection with the completion of the above said project report to our satisfaction. The report prepared by the student is for the submission to the respective institution & is for the academic purpose only.

Her conduct and behaviour during the above period were good.

GENERAL MANAGER
General Manager
K.S.I.C. Unit: Silk Weaving Factory
MYSORE - 570 008

Karnataka Silk Industries Corporation Ltd., (A Government of Karnataka Undertaking)

Unit : Silk Weaving Factory, Mananthody Road, Mysore - 570 008 - India

Registered Office : III & IV Floors, Public Utility Building, Mahatma Gandhi Road, Bangalore - 560 001

Phone No. 2481803, 2485303 Fax : 0821 - 2483544 E-mail : gmksic @dataone.in

UNIVERSITY OF MYSORE



“An Analytical Study on Organizational Culture and its impact on Employee Performance with special reference to Siderforgerossi India Pvt. Ltd.”

Submitted by:

SANJAY.L

Reg. No: P01BG21C0033

Internal Guide :

Dr. Jyothi A N

Assistant Professor

Department of Commerce

P.G Centre –M.Com

Sarada Vilas College. Mysore

External Guide :

Mr. Manu. N

Executive HR

Siderforgerossi India Pvt.

Ltd Metgalli Post

Mysore-570016

Submitted To:

University of Mysore

In partial fulfilment of award of Post Graduate Degree in Commerce (M.Com)

Department of Commerce P.G Centre-M.Com

Sarada Vilas College Mysore



SARADA VILAS EDUCATIONAL INSTITUTIONS (Regd.)

SARADA VILAS COLLEGE

Krishnamurthypuram, Mysore – 570 004 Karnataka

Affiliated to University of Mysore

Re accredited by NAAC with B+ grade (CGPA: 2.70)



Date : 05/09/2023

Certification

This is to certify that Mr. SANJAY L (Reg. No. P01BG21C0033) is a bonafide student of PG Centre - M.Com, Sarada Vilas College, studying M.Com final year in the academic year 2022-2023. As a part of his final examination M.Com he has prepared a project report on **"An Analytical Study on Organizational Culture and its Impact on Employee Performance with special reference to Siderforgerossi India Pvt.Ltd"**, under the guidance of Dr. Jyothi A N, Assistant Professor, PG Centre - M.Com, Sarada Vilas College, Mysuru. I certify that, this project work is his original work and not presented to any other University / Institution for award of any Degree/Diploma.

Dean

Chairperson

Sarada Vilas College

Mysuru

Principal

Dr. M Davika

M.Sc., M.Phil., Ph.D.

Principal

Sarada Vilas College,

Krishnamurthypuram, Mysuru



SFRG/HRD/23-24/07

Date: 01.08.2023

CERTIFICATE

This is to certify that Mr. SANJAY L Bearing Rge. No P01BG21C0033 Pursuing his Second year, 4th semester M Com at Sarada Vilas College, Mysore has completed his Project Work on "An Analytical Study on Organizational Culture and its impact on Employee Performance with special reference to Siderforgerossi India Private Limited" from 02.05.2023 to 31.07.2023. Under the guidance of Mr.Manu N – Executive HR & Admin department in our Organization.

He has shown interest in learning and his Conduct & Character was good. We wish him all the best for his future endeavors.

For Siderforgerossi India Private Limited.,

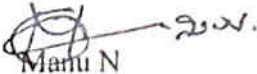
Manu N

Executive-HR

A
Project Report
On
A Study On “Impact Of Performance Appraisal System On
Employees Performance In Triveni Engineering And Industrial
Limited” Mysuru.

Submitted By
SAHANA.B
REG.NO. P01BG21C0022

External Guide

Santhosh Sir
HR Officer
Triveni Gear limited Mysuru

Internal Guide

Dr. Jyothi A.N
Dept of commerce PG centre
Sarada Villas College, Mysore

Submitted to
University of Mysore

In partial Fulfillment of award of Post Graduate Degree in Commerce
(M.Com)

Department of Commerce P.G Centre- M.Com
Sarada Villas College, Mysuru

Phone: 0821-2332479, Fax: 0821-2330221

E-mail: principal@saradavilas.com

website: www.saradavilas.com



SARADA VILAS EDUCATIONAL INSTITUTIONS (Regd.)

SARADA VILAS COLLEGE

Krishnamurthypuram, Mysore - 570 004 Karnataka

Affiliated to University of Mysore

Re accredited by NAAC with B+ grade (CGPA: 2.70)



Date :

Certification

This is to certify that Ms. SAHANA B (Reg. No. P01BG21C0022) is a bonafide student of PG Centre - M.Com, Sarada Vilas College, studying M.Com final year in the academic year 2022-2023. As a part of her final examination M.Com she has prepared a project report on "**A Study on the Impact of Performance Appraisal System on Employees' Performance in Triveni Engineering and Industries Ltd., Mysuru**", under the guidance of Dr. Jyothi A N, Assistant Professor, PG Centre - M.Com, Sarada Vilas College, Mysuru. I certify that, this project work is her original work and not presented to any other University / Institution for award of any Degree/Diploma.

Dean

Dean Commerce and Busi, Admn.
Sarada Vilas College
Mysuru-570 004

Principal

M. Devika
M.Sc., M.Phil., Ph.D.
Principal
Sarada Vilas College,
Krishnamurthypuram, Mysuru

Date: August 12, 2023

Ref : TEIL/MYS/HR/23

CERTIFICATE

This is to certify that **Ms. SAHANA B** a student of M. Com, Sarada Villas College PG-Centre, Mysore with USN : **P01BG21C0022** has successfully completed project work on **“A Study on Impact of Performance Appraisal System on Employee Performance in Triveni Engineering Ltd, Mysore”** at Triveni Engineering and Industries Ltd., Mysuru. The project work is done during the period from 20.04.2023 TO 07.06.2023, under the guidance of Mr. Santhosh K – Sr. Officer (HR).

We wish her all success in her future endeavor.

For **Triveni Engineering and Industries Ltd.,**

Santhosh K
Sr. Officer (HR)

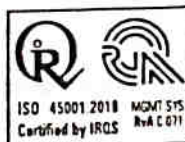

A
Project Report
On

“A Study of Selling Strategy of the Packaging Products Manufacturing Industry
with Reference to Shukra Packaging Private Limited” Mysuru.

Submitted by
Madhu M

Reg. No: P01BG21C0007

Internal Guide

Dr. Jyothi A N
Assistant Professor
Department of Commerce
P. G Centre- M. Com
Sarada Vilas College, Mysuru

External Guide

Mr. M Manoj Shenoy
Managing Director
Shukra Packaging
Private Limited,
Mysuru

Submitted To
University of Mysuru

In partial fulfillment of award of Post Graduate Degree in Commerce (M. Com)

Department of Commerce P.G Centre-M com

Sarada Vilas College, Mysuru.

Phone: 0821-2332479, Fax: 0821-2330221

E- mail: principal@saradavilas.com

website: www.saradavilas.com



SARADA VILAS EDUCATIONAL INSTITUTIONS (Regd.)

SARADA VILAS COLLEGE

Krishnamurthypuram, Mysore – 570 004 Karnataka

Affiliated to University of Mysore

Re accredited by NAAC with B+ grade (CGPA: 2.70)



Date: 5/9/23

Certification

This is to certify that Mr. MADHU M (Reg. No. P01BG21C0007) is a bonafide student of PG Centre - M.Com, Sarada Vilas College, studying M.Com final year in the academic year 2022-2023. As a part of his final examination M.Com he has prepared a project report on "A Study of Selling Strategy of the Packaging Products Manufacturing Industry with Reference to Shukra Packaging Private Limited, Mysuru", under the guidance of Dr. Jyothi A N, Assistant Professor, PG Centre - M.Com, Sarada Vilas College, Mysuru. I certify that, this project work is his original work and not presented to any other University / Institution for award of any Degree/Diploma.

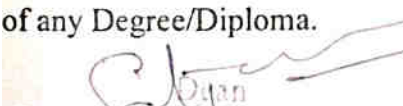
Commerce and Busi. Admn.
Sarada Vilas College
Mysuru-570 004
Dean

Principal
Dr. M Devika
M.Sc., M.Phil., Ph.D.
Principal
Sarada Vilas College
Krishnamurthypuram, Mysuru.



Shukra

PACKAGING PVT. LTD.

Corrugated Box Manufacturers
5 Ply / 3 Ply Auto Plant



..... Sppl

Date 02.08.2023

CERTIFICATE

This is to certify that Mr. Madhu M (Reg. No: PO1BG21C0007) Studying M.com in Sarada Vilas college, Mysore has done "Project Work" from 01.03.2023 to 29.04.2023 in our union successfully.

We wish him all the very best for him future endeavors.



*We can print & Pack your
Dreams too ...!*

19/A, Industrial Suburb, Mysuru South, Mysuru - 570008 INDIA

website : www.shukrapack.com

Tel. : 0821 - 2481668, 2481667 (Off.) | Cell : 09845835677, 09632620077

mail : shukrapack@yahoo.co.in | shukrapack@gmail.com | acc_shukrapack@yahoo.com

A

PROJECT REPORT
ON
“AN EVALUATION OF TEACHING SKILLS OF THE
FACULTY IN JYOTHI COMPOSITE PU COLLEGE,
KUVEMPUNAGAR MYSURU”

Submitted by

PRIYANKA S

Reg. No: P01BG21C0016

Under the Guidance of

Internal Guide

Dr. Jyothi A N

Assistant Professor

Department of Commerce

P.G Centre-M.Com

Sarada Vilas College, Mysuru.

External Guide

Dr. Bharat Raj B

Principal

Jyothi composite PU College

Mysuru.

Submitted To,

University of Mysore

In partial fulfillment of award of post Graduate Degree in

Commerce (M.Com)

Department of Commerce P.G Centre – M.Com

Sarada Vilas College, Mysuru.

2022 - 23



Phone: 0821-2332479, Fax: 0821-2330221

E- mail: principal@saradavilas.com

website: www.saradavilas.com

SARADA VILAS EDUCATIONAL INSTITUTIONS (Regd.)

SARADA VILAS COLLEGE

Krishnamurthypuram, Mysore – 570 004 Karnataka

Affiliated to University of Mysore

Re accredited by NAAC with B+ grade (CGPA: 2.70)



Date : 5/9/2023

Certification

This is to certify that Ms. PRIYANKA S (Reg. No. P01BG21C0016) is a bonafide student of PG Centre - M.Com, Sarada Vilas College, studying M.Com final year in the academic year 2022-2023. As a part of her final examination M.Com she has prepared a project report on "An Evaluation of Teaching Skills of the Faculty in Jyothi Composite PU College, Kuvempunagar, Mysore" under the guidance of Dr. Jyothi A N, Assistant Professor, PG Centre - M.Com, Sarada Vilas College, Mysuru. I certify that, this project work is her original work and not presented to any other University / Institution for award of any Degree/Diploma.

Dean

Dean
Commerce and Busi. Admn.
Sarada Vilas College
Mysuru-570 004

Principal

Dr. M Devika

M.Sc., M.Phil., Ph.D.

Principal

Sarada Vilas College,
Krishnamurthypuram, Mysuru



ಜ್ಯೋತಿ ಸಂಯುಕ್ತ ವಿಜ್ಞಾನ ಪದವಿಪೂರ್ವ ಕಾಲೇಜು
JYOTHI COMPOSITE SCIENCE P.U. COLLEGE
 Kuvempunagar, Mysore - 570 023

Mob : 8147715585

: ಜೊ.ಪ.ಪೂ.ಕಾ.

13/2023-24

ದಿನಾಂಕ 01-08-2023

CERTIFICATE

This is to certify that Ms. PRIYANKA S (Reg. No. P01BG21C0016) IV Semester M.Com Student of Sarada Vilas College, PG Centre, Mysore affiliated to University of Mysore has undergone the project work on "An Evaluation of Teaching Skills of the Faculty in Jyothi Composite PU College, Mysore". She has successfully worked under the guidance of Dr. Bharath Raj B, Principal, Jyothi Composite PU College, Kuvempunagara, Mysore. We wish her all the success in her future endeavor.

Place : Mysore

 PRINCIPAL

Jyothi Composite PU College
 NN0283
 Kuvempunagara, Mysuru

GUIDE CERTIFICATE

I hereby declare that the project report entitled "An Evaluation of Teaching Skills of the Faculty in Jyothi Composite PU College, Kuvempunagar, Mysore" is an authentic record of the bonafide work carried out by Ms. PRIYANKA S (Reg. No. P01BG21C0016), under my guidance and supervision. This report is prepared and submitted to the University of Mysore, Mysuru in partial fulfillment of the PG course in Commerce (M.Com). She is a bonafide student of M.Com final year Department of Commerce, PG Centre - M.Com, Sarada Vilas College in the year 2022-23. This report has not been published and submitted to any other university/institution for award of any degree or diploma.

Place: Mysuru

Date: 5/9/2023

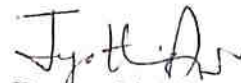
Dr. Jyothi A N

Assistant Professor
Department of Commerce,
PG Centre-M.Com
Sarada Vilas College,
Mysuru.

Project Report

**"An Empirical Study of Issues and Challenges faced by Wood Industry in Marketing
with reference to Sri Balaji Wooden Furniture Industry, Hunsur"**

Submitted by

Vinutha. S

Reg No. P01BG21C0008

Internal Guide

Dr. Jyothi. A N

Sarada Vilas college Mysuru

External Guide

Mr. Moksha Prasad

Hunsur

Submitted to,

UNIVERSITY OF MYSORE

In partial fulfilment of award of Post Graduate Degree in commerce

Department of commerce PG Centre M. Com

Sarada Vilas College, Mysuru

Phone: 0821-2332479, Fax: 0821-2330221

E-mail: principal@saradavilas.com

website: www.saradavilas.com



SARADA VILAS EDUCATIONAL INSTITUTIONS (Regd.)

SARADA VILAS COLLEGE

Krishnamurthypuram, Mysore - 570 004 Karnataka

Affiliated to University of Mysore

Re accredited by NAAC with B+ grade (CGPA: 2.70)



Date: 5/9/23

Certification

This is to certify that Ms.VINUTHA S (Reg. No. P01BG21C0008) is a bonafide student of PG Centre - M.Com, Sarada Vilas College, studying M.Com final year in the academic year 2022-2023. As a part of her final examination M.Com she has prepared a project report on "An Empirical Study of Issues and Challenges faced by Wood Industry in Marketing with reference to Sri Balaji Wooden Furniture Industry, Hunsur", under the guidance of Dr. Jyothi A N, Assistant Professor, PG Centre - M.Com, Sarada Vilas College, Mysuru. I certify that, this project work is her original work and not presented to any other University / Institution for award of any Degree/Diploma.

Dean
Commerce and Busi, Admn.
Sarada Vilas College
Mysuru-570 004

Principal
Dr. M Devika
M.Sc, M.Phil, Ph.D.
Principal
Sarada Vilas College,
Krishnamurthypuram, Mysuru

Certificate

This is to certify that Ms. vinutha. S (Reg. No: P01BG21C0008) 5th semester M.com student of Sarada villas college, PG centre, Mysore affiliated to university of Mysore has undergone the project work on "An Empirical study of issues and challenges faced by furniture wood industry in marketing with reference to Sri Balaji Wooden furniture industry. Hunsur".

She has successfully worked under the guidance of Mr. Moksha prasad Sri Balaji Wooden Furniture industry Hunsur.

We wish her all success in her future endeavour.

For Sri Balaji Wooden furniture industry.

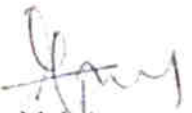
Mr. Moksha prasad

Place: Hunsur

SRI BALAJI
Wood Furniture Industries
(Recognised by Govt. of Karnataka State,
Khadi Village Industries Board) B'lore,
2 C-7, Industrial Area, D. M. Road, HUNSUR,
Mysore Dist., KARNATAKA Pin-571 105,
TIN: 29920765224

A
Project Report

On

**“A STUDY ON INDUSTRIAL ACCIDENTS-CAUSES, EFFECTS AND
MEASURES WITH SPECIAL REFERENCE TO BEML MYSORE
UNIT”**

Submitted by

NAVYASHREE.S

Reg No: P01BG21C0015

Internal Guide:

Dr. Jyothi A N
Assistant Professor
Department of Commerce
P.G Centre-M.Com
Sarada Vilas College
Mysore.

External Guide:

Shri. Venkatesh K R
General Manager
Safety Department
BEML LIMITED
Mysore.

Submitted To

University of Mysore

In partial fulfillment award of post Graduate Degree in Commerce (M. Com)

Department of Commerce P.G Centre-M.Com

Sarada Vilas College, Mysore.

Phone: 0821-2332479, Fax: 0821-2330221

E- mail: principal@saradavilas.com

website: www.saradavilas.com

SARADA VILAS EDUCATIONAL INSTITUTIONS (Regd.)

SARADA VILAS COLLEGE

Krishnamurthypuram, Mysore – 570 004 Karnataka

Affiliated to University of Mysore

Re accredited by NAAC with B+ grade (CGPA: 2.70)



Date : 05/09/2023

Certification

This is to certify that Ms. NAVYASHREE S (Reg. No. P01BG21C0015) is a bonafide student of PG Centre - M.Com, Sarada Vilas College, studying M.Com final year in the academic year 2022-2023. As a part of her final examination M.Com she has prepared a project report on "A Study on Industrial Accidents - Causes, Effects and Measures with special reference to BEML, Mysore Unit", under the guidance of Dr. Jyothi A N, Assistant Professor, PG Centre - M.Com, Sarada Vilas College, Mysuru. I certify that, this project work is her original work and not presented to any other University / Institution for award of any Degree/Diploma.

Dean

Dean

Commerce and Busi, Admn.
Sarada Vilas College
Mysuru-570 004

Principal

Dr. M Devika

M.Sc., M.Phil., Ph.D.

Principal

Sarada Vilas College,
Krishnamurthypuram, Mysuru

Ref: TKT/137(C)/2023

Date: 17.08.2023

To Whomsoever It May Concern
Project work Certificate

This is to certify that Ms. NAVYASHREE S, Reg. No. P01BG21C0015, M.Com Student of Sarada Vilas College, PG Centre, University, Mysuru, has successfully undergone Project work on "A Study on Industrial accidents-causes, effects and Measures with special reference to BEML Ltd Mysore Complex" under the guidance of Shri. Venkatesh K R, Asst. General Manager Safety department w.e.f. 09.08.2023 to 17.08.2023. During her stay at BEML Limited, her Character and Conduct was found Good .

We wish Ms. NAVYASHREE S, ALL THE BEST in her future Endeavours.

for BEML LIMITED

Ar.

ARUNKUMAR T S

Asst. General Manager [Training]

अरुण कुमार टि.एम.

ARUN KUMAR T.S.

सहायक महा प्रबंधक, प्रशिक्षण केंद्र

Asst.Gen. Manager, Training Centre

बीईएमएल लिमिटेड, मैसूर कॉम्प्लेक्स

BEML LIMITED, MYSORE COMPLEX

बेलवाडी पोस्ट, मैसूर-570 018

Belavadi Post, MYSURU-570 018

Corporate Office :

24/0, 4th Main, S R Nagar, Bangalore-560027

☎ +91 821 2400288, 2400324

2296 3200, 1800 425 2365

2296 3200, 1800 425 2365

KA1964GOI001530, GST No. : 29AAACB8433D1ZU

153

www.bemlindia.in

ಉತ್ಪಾದನಾ ಘಟಕ : ಬೆಂಗಳೂರು ಕಂಪ್ಲೆಕ್ಸ್

ಬೆಂಗಳೂರು ಪೋಸ್ಟ್, ಮೈಸೂರು - 570 018

ದೂರವಾರ್ತೆ ಸಂಖ್ಯೆ : + 91 821 2400288, 2400324

ಇ-ಮೇಲ್ : tkt@beml.co.in

Manufacturing Unit : Mysore Complex,

Belavadi Post, Mysuru - 570 018

Tel. +91 821 2400288, 2400324

e-mail : tkt@beml.co.in

Project report

“A STUDY ON EMPLOYEE SATISFACTION IN CYCLE
PURE AGARBATTICOMPANY, MYSORE”

Submitted by

RADHIKA S

Reg No: P01BG21C0006

Internal guide

Dr. Jyothi A N
Department of commerce
P.G centre- M.com
Sarada Vilas College,
Mysore

External guide

Mr DHARMAPAL
N Ranga Rao & son
PVT LTD Mysore

Submitted to

University of Mysore

In partial fulfillment of award of post graduate degree in commerce (M.COM)

Department of commerce P.G centre-M.COM



SARADA VILAS EDUCATIONAL INSTITUTIONS (Regd.)

SARADA VILAS COLLEGE

Krishnamurthypuram, Mysore - 570 004 Karnataka

Affiliated to University of Mysore

Re accredited by NAAC with B+ grade (CGPA: 2.70)



Date : 5/9/23

Certification

This is to certify that Ms. RADHIKA S (Reg. No. P01BG21C0006) is a bonafide student of PG Centre - M.Com, Sarada Vilas College, studying M.Com final year in the academic year 2022-2023. As a part of her final examination M.Com she has prepared a project report on "A Study on Employee Satisfaction in Cycle Pure Agarbatti Company, Mysore", under the guidance of Dr. Jyothi A N, Assistant Professor, PG Centre - M.Com, Sarada Vilas College, Mysuru. I certify that, this project work is her original work and not presented to any other University / Institution for award of any Degree/Diploma.

Dean
Commerce and Busi. Admn.
Sarada Vilas College
Mysuru-570 004

Dean

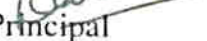
Principal
Dr. M Devika
M.Sc., M.Phil., Ph.D.
Principal
Sarada Vilas College,
Krishnamurthypuram, Mysuru

To
Satyanarayana
Prof & Dean
Dept. of Commerce & Business Administration
Sharada Vilas College
Mysore

Date: 31 August, 2023

To Whom So Ever It May Concern

This is to certify that, Ms. Radhika S ((Reg No: P01BG21C0006), student of M.Com from Sharada Vilas College Mysore, has successfully completed her Project work at N Ranga Rao & Sons Pvt Ltd" on "A Study On Employee Satisfaction". The Project commenced from 12.05.2023 and ended on 26.08.2023 under the guidance of Mr. Dharmapal B A – Manager - HR

We appreciate Radhika's adaptability, positive attitude and eagerness to learn observed during this Project period.

We wish her all the success in future.

For N Ranga Rao & Sons Pvt Ltd,



Authorized Signatory

Project Report

**“AN EMPERICAL STUDY ONTHE STRESS OF EMPLOYEES -
AT WORK PLACE IN MYMUL”**

Submitted by

MANUSHREE. S

Reg. No: P01BG21C0011

Internal Guide

Dr. Jyothi A.N

Head of the department

P.G Center M.com

Sarada Vilas college Mysuru

External Guide

Shwetha

Assistant Manager (Admin)

Mysuru Dist. Co-operative Milk

Producer's Societies Union Ltd.

Submitted To

University of Mysore

In partial fulfillment of award of Post Graduate Degree in Commerce (M. Com)

Department of Commerce P.G Centre-M.com

Sarada Vilas College, Mysuru.



SARADA VILAS EDUCATIONAL INSTITUTIONS (Regd.)

SARADA VILAS COLLEGE

Krishnamurthypuram, Mysore – 570 004 Karnataka
Affiliated to University of Mysore
Re accredited by NAAC with B+ grade (CGPA: 2.70)



Date : 05/09/2023

Certification

This is to certify that Ms. MANUSHREE S (Reg. No. P01BG21C0011) is a bonafide student of PG Centre - M.Com, Sarada Vilas College, studying M.Com final year in the academic year 2022-2023. As a part of her final examination M.Com she has prepared a project report on **"An Empirical Study on the Stress of Employees at Work Place in MYMUL"**, under the guidance of Dr. Jyothi A N, Assistant Professor, PG Centre - M.Com, Sarada Vilas College, Mysuru. I certify that, this project work is her original work and not presented to any other University / Institution for award of any Degree/Diploma.

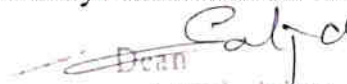
Dean
Commerce and Busi. Admn.
Sarada Vilas College
Mysuru-570 004
Dean

Principal
Dr. M Devika
M.Sc., M.Phil, Ph.D.
Principal
Sarada Vilas College,
Krishnamurthypuram, Mysuru



ಮೈಸೂರು ಜಿಲ್ಲಾ ಸಹಕಾರಿ ಹಾಲು ಉತ್ಪಾದಕರ ಸಂಘಗಳ ಒಕ್ಕೂಟ ನಿ.

Mysuru Dist. Co-operative Milk Producer's Societies Union Ltd.



Certified Dairy

No.467: Admn:2023

Date 25.07.2023

CERTIFICATE

This is to certify that Ms. Manushree.S, (Reg No: P01BG21C0011) studying M.Com in Sarada Vilas College, Mysuru has done "Project Work" from 01.03.2023 to 29.04.2023 in our Union successfully.

We wish her all the very best for her future endeavors.

Shrutha

Assistant Manager (Admin)

Assistant Manager (Admin)

Mysuru Dist. Co-operative Milk

Producer's Societies Union Ltd.

Mysuru-570 028

ಮೆಗಾ ಡೈರಿ ಸಂಕೀರ್ಣ, ಬನ್ನೂರು ರಸ್ತೆ, ಅಲನಹಳ್ಳಿ ಅಂಚೆ, ಮೈಸೂರು - 570 028

Mega Dairy Complex, Bannur Road, Alanahalli Post, Mysuru-570 028

Ph : 0821-2473923, 2473933 Fax : 0821-2472797, 2474476

mymul@gmail.com, purmymul@gmail.com, mismymul@gmail.com, mymuladmn@gmail.com Website : www.mymul.coop

GUIDE CERTIFICATE

I hereby declare that the project report entitled "An Empirical Study on the Stress of Employees at Work Place in MYMUL" is an authentic record of the bonafide work carried out by Ms. MANUSHREE S (Reg. No. P01BG21C0011), under my guidance and supervision. This report is prepared and submitted to the University of Mysore, Mysuru in partial fulfillment of the PG course in Commerce (M.Com). She is a bonafide student of M.Com final year at Department of Commerce, PG Centre - M.Com, Sarada Vilas College in the year 2022-23. This report has not been published and submitted to any other university/institution for award of any degree or diploma.

Place: Mysuru

Date: 05/09/2023

Dr. Jyothi A N

Assistant Professor
Department of Commerce,
PG Centre-M.Com
Sarada Vilas College,
Mysuru.

PROJECT REPORT

**“GYM AS A SOLUTION TO HEALTH LIFE AND LONG LIFE-
A CASE STUDY WITH NIE COLLEGE FITNESS CENTRE MYSURU”.**

SUBMITTED BY

SANTHOSH VARDHAN, V

REG. NO: P01BG21C0019

INTERNAL GUIDE

DR. JYOTHI A N

Assistant professor

PG centre M. com

Sarada Vilas College, Mysore

EXTERNAL GUIDE

MRS. KAVYA.R

Head of the department

of Physical Education

NIE College, Mysore

SUBMITTED TO

University of Mysuru

In partial fulfillment of award of Post Graduate Degree in Commerce (M. Com)

Department of Commerce P.G Centre-M.com

Sarada Vilas College, Mysuru.



SARADA VILAS EDUCATIONAL INSTITUTIONS (Regd.)

SARADA VILAS COLLEGE

Krishnamurthy Puram, Mysore - 570 004 Karnataka

Affiliated to University of Mysore

Re-accredited by NAAC with B+ grade (CGPA: 2.70)



Date: 5-9-2023

Certification

This is to certify that Mr. SANTHOSH VARDHAN V (Reg. No. P01BG21C0019) is a bonafide student of PG Centre - M.Com, Sarada Vilas College, studying M.Com final year in the academic year 2022-2023. As a part of his final examination M.Com he has prepared a project report on "**Gym as a Solution to Healthy Life and Long Life - A case study with NIE College Fitness Centre, Mysuru**", under the guidance of Dr. Jyothi A N, Assistant Professor, PG Centre - M.Com, Sarada Vilas College, Mysuru. I certify that, this project work is his original work and not presented to any other University / Institution for award of any Degree/Diploma.

Dean

Dean
Commerce and Busi. Admn.
Sarada Vilas College
Mysuru-570 004

Principal

Dr. M Devika

M.Sc., M.Phil., Ph.D.
Principal
Sarada Vilas College,
Krishnamurthy Puram, Mysuru



1946

The National Institute of Engineering

(An Autonomous Institution under Visvesvaraya Technological University, Belagavi)

- Recognised by AICTE, New Delhi • Accredited by National Board of Accreditation, New Delhi
- Grant-in-Aid by Government of Karnataka

J. Kavya R. M.P.Ed
Physical Education Director

Date: 01/08/2023
email: sports@nie.ac.in

CERTIFICATE

This is to certify that **Santhosh Vardhan.V** (reg. no P01BG21C0019) IV semester **M.com** student of Sarada Vilas College, PG Center, Mysuru, affiliated to University of Mysore has undergone the project work on “GYM AS A SOLUTION TO HEALTH LIFE AND LONG LIFE- A CASE STUDY WITH NIE COLLEGE FITNESS CENTRE MYSURU”. He has successfully worked under my guidance.

We wish his all the success in future endeavor.

For NIE Fitness Center, Department of Physical Education & Sports, The National Institute of Engineering, Mysuru.

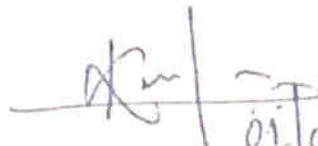
01/08/2023
Physical Education Director
THE NATIONAL INSTITUTE OF ENGINEERING
MYSURU-570008

Manandavadi Road, Mysuru – 570 008, Karnataka, India
Phone: 91-821-2480475, 2481220, 4004900, Fax: 91-821-2485802
Email : principal@nie.ac.in, principalnie@yahoo.com, web: www.nie.ac.in

A

Project report

On

"ANALYTICAL STUDY ON CUSTOMER TRUST AND BUYING PATTERN IN
CHAMUNDESWARI TRADERS LTD, BANNUR."

Submitted By

RAMACHANDRA.B

Reg. No. P01BG21C0021

Internal Guide

Dr. Jyothi A N

Assistant Professor

Department of commerce

P. G Centre -M. Com, SVC, Mysuru

External Guide

Mr. P. Manju

Proprietor of

Sri Chamundeshwari traders,

Bannur

Submitted To

University of Mysore

In partial fulfilment of award of Post Graduate Degree in Commerce (M. Com)

Department of Commerce P G centre – M. Com

Sarada Vilas College, Mysuru



Phone: 0821-2332479, Fax: 0821-2330221

E-mail: principal@saradavilas.com

website: www.saradavilas.com

SARADA VILAS EDUCATIONAL INSTITUTIONS (Regd.)

SARADA VILAS COLLEGE

Krishnamurthypuram, Mysore - 570 004 Karnataka

Affiliated to University of Mysore

Re accredited by NAAC with B+ grade (CGPA: 2.70)



Date: 06/09/2023

Certification

This is to certify that Mr. RAMACHANDRA B (Reg. No. P01BG21C0021) is a bonafide student of PG Centre - M.Com, Sarada Vilas College, studying M.Com final year in the academic year 2022-2023. As a part of his final examination M.Com he has prepared a project report on "An Analytical study on Trust and Buying Pattern in Chamundeshwari Traders Ltd, Bannur", under the guidance of Dr. Jyothi A N, Assistant Professor, PG Centre - M.Com, Sarada Vilas College, Mysuru. I certify that, this project work is his original work and not presented to any other University / Institution for award of any Degree/Diploma.

Dean

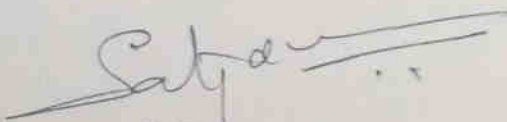
Dean
Commerce and Busi. Admn.
Sarada Vilas College
Mysuru-570 004

Principal

Dr. M Devika
M.Sc., M.Phil., Ph.D.
Principal
Sarada Vilas College
Krishnamurthypuram, Mysore

A
Project Report
On
A Study On “The Challenges In Adoption Of Solar Technologies In Day To
Day Life In Eagle Technologies Mysuru”

Submitted By

NAGARAJU P

REG.NO. P01BG21C0051

External Guide

Sathish Kumar Sir
Branch Manager
Eagle Technologies,
Mysuru

Internal Guide

Dr. Jyothi A.N
Dept. of Commerce PG Centre
Sarada Villas College, Mysuru

Submitted to

University of Mysore

In partial Fulfillment of award of Post Graduate Degree In Commerce (M.Com)

Department of Commerce P.G Centre- M.Com

Sarada Villas College, Mysuru



SARADA VILAS EDUCATIONAL INSTITUTIONS (Regd.)

SARADA VILAS COLLEGE

Krishnamurthypuram, Mysore - 570 004 Karnataka

Affiliated to University of Mysore

Re accredited by NAAC with B+ grade (CGPA: 2.70)



Date : 05/09/2023

Certification

This is to certify that Mr. NAGARAJU P (Reg. No. P01BG21C0051) is a bonafide student of PG Centre - M.Com, Sarada Vilas College, studying M.Com final year in the academic year 2022-2023. As a part of his final examination M.Com he has prepared a project report on **"A Study on the Challenges In Adoption of Solar Technologies In Day-To-Day Life In Eagle Technologies Mysuru."**, under the guidance of Dr. Jyothi A N, Assistant Professor, PG Centre - M.Com, Sarada Vilas College, Mysuru. I certify that, this project work is his original work and not presented to any other University / Institution for award of any Degree/Diploma.

Dean

Dean
Commerce and Busi. Admn.
Sarada Vilas College
Mysuru-570 004

Principal

Dr. M Devika

M.Sc, M.Phil, Ph.D.

Principal

Sarada Vilas College,
Krishnamurthypuram, Mysuru

CERTIFICATES

This is to certify that Mr. Nagaraju P. (P01BG21C0051) studying final year M.com in Sarada Vilas College, PG centre, Mysuru, affiliated to university of Mysuru.

He done successfully completed his "PROJECT WORK" on "A study on the challenges in adoption of solar technologies in day to day life".

We wish all the best for his future endeavour.

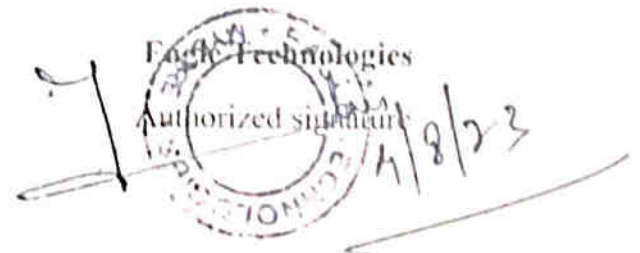

Eagle Technologies
Authorized signature
4/8/23

A
PROJECT REPORT
On

**An Analytical Study on the Service Methods Adopted by MYMUL and its
Influence on Buying Behaviour of Consumers.**

Submitted by
Ramya T
Reg. No: P01BG21C0009

Internal Guide

Dr. Jyothi A N
Department of Commerce
PG Centre-M.com
Sarada Vilas College, Mysuru.

External Guide

Mrs. Shwetha
Assistant Manager
MYMUL.

Submitted to
University of Mysore

In partial fulfilment of award of post Graduate Degree in Commerce – M.Com
Department of commerce and Business Administration,
PG Centre – M.com
Sarada Vilas College, Mysuru



SARADA VILAS EDUCATIONAL INSTITUTIONS (Regd.)

SARADA VILAS COLLEGE

Krishnamurthypuram, Mysore – 570 004 Karnataka

Affiliated to University of Mysore

Re accredited by NAAC with B+ grade (CGPA: 2.70)



Date : 05/09/2023

Certification

This is to certify that Ms. RAMYA T (Reg. No. P01BG21C0009) is a bonafide student of PG Centre - M.Com, Sarada Vilas College, studying M.Com final year in the academic year 2022-2023. As a part of her final examination M.Com she has prepared a project report on **"An Analytical Study on the Service Methods Adopted by MYMUL and its Influence on Buying Behaviour of Consumers"**, under the guidance of Dr. Jyothi A N, Assistant Professor, PG Centre - M.Com, Sarada Vilas College, Mysuru. I certify that, this project work is her original work and not presented to any other University / Institution for award of any Degree/Diploma.

Dean 
Commerce and Busi. Admn.
Sarada Vilas College
Mysuru-570 004
Dean

Principal

Dr. M Devika
M.Sc., M.Phil., Ph.D.
Principal
Sarada Vilas College,
Krishnamurthypuram, Mysuru



ಮೈಸೂರು ಜಿಲ್ಲಾ ಸಹಕಾರಿ ಹಾಲು ಉತ್ಪಾದಕರ ಸಂಘಗಳ ಒಕ್ಕೂಟ ನಿ.

Mysore District Co-Operative Milk Producers' Societies Union Ltd.



No.467:EST:2023

Date 01.08.2023

CERTIFICATE

This is to certify that Ms. Ramya.T, studying M.Com at Sarada Vilas College, Mysuru has done the Project Work from 01.06.2023 to 31.07.2023 in our Union successfully.

We wish her all the very best for her future endeavors.

Assistant Manager (Admin)

Assistant Manager (Admin)

Mysuru Dist. Co-operative Milk
Producer's Societies Union Ltd.,
Mysuru-570 028

ಮೆಗಾ ಡೈರಿ ಸಂಕೀರ್ಣ, ಬನ್ನೂರು ರಸ್ತೆ, ಆಲನಹಳ್ಳಿ ಅಂಚೆ, ಮೈಸೂರು - 570 028

Mega Dairy Complex, Bannur Road, Alanahalli Post, Mysuru - 570 028

Ph : 0821-2473923, 2473933, Fax : 0821-2472797, 2474476

mdmymul@gmail.com, purmymul@gmail.com, mismymul@gmail.com, mymuladm@gmail.com, Website : www.mymul.coop

Project Report

“ A Study on the Influencing factor for a fast moving variant of the two – wheeler vehicle in SONA HUNSUR”

Submitted By

Rakshitha H M

REG. NO. P01BG21C0013

Internal Guide

Mrs. Pragathi K

Assistant Professor

Department of Commerce

Sarada Vilas College Mysore

External Guide

Mr. Ravi Kadam

Manager

Hunsur

Submitted to

University of Mysore

In partial Fulfillment of award of Post Graduate Degree in Commerce (M com)

Department of Commerce P.G Centre M.com.

Sarada Vilas college Mysore



SARADA VILAS EDUCATIONAL INSTITUTIONS (Regd.)

SARADA VILAS COLLEGE

Krishnamurthypuram, Mysore – 570 004 Karnataka

Affiliated to University of Mysore

Re accredited by NAAC with B+ grade (CGPA: 2.70)



Date : 05/09/23

CERTIFICATION

This is to certify that **Ms. Rakshitha HM (Reg. No. P01BG21C0013)** is a bonafide student of PG Centre-M.Com, Sarada Vilas College, studying M.Com final year in the academic year 2022-2023. As a part of her final examination M. Com she has prepared a project report " **A Study on the influencing factor for a fast-moving variant of the two-wheeler vehicle in Sona Hunsur**" under the guidance of Mrs. Pragathi.K Assistant Professor, PG Centre-M.Com, Sarada Vilas College, Mysuru. I certify that, this project work is her original work and not presented to any other University / Institution for award of any Degree/Diploma.

Dean

Dean

Commerce and Busi, Admn.
Sarada Vilas College
Mysuru-570 004

Principal

Dr. M Devika

M.Sc., M.Phil., Ph.D.

Principal

Sarada Vilas College,
Krishnamurthypuram, Mysuru



SONA HUNSUR TVS

By Pass Road,
HUNSUR - 571 105
Ph : 92427 80202
E-Mail : tvshunsur@gmail.com
Authorised Dealer :
TVS Motor Company Limited

CERTIFICATE

This is to certify that **Ms. Rakshitha H M. (Reg. No P01BG21C0013)** IV semester M COM Student of Sarada Vilas Collage, PG Centre, Mysore, affiliated to University of Mysore has undergone the project work on

"A STUDY ON THE INFLUENCING FACTORE FOR A FAST MOVING VARIANT OF THE TWO WHEELER VEHICLE IN SONA HUNSUR."

She has successfully worked under my guidance.

We wish her all the success in her future endeavor.

FOR SONA HUNSUR TVS

Ravi Kadam
RAVI KADAM

(MANAGER)

PLACE: HUNSUR

DATE: 05/09/23

A
Project Report

On

“Shri Kshethra Dharmasthala Rural Development Project – A Review with an
Intention of Analyzing the Impact of projects an Economic, Culture and
Spiritual aspect as rural people”

Submitted by

Suma M K

Reg. No: P01BG21C0005

Internal guide

Mrs. Pragathi. K
Assistant. Professor
Department of Commerce
P.G Center – M. Com
Sarada Vilas College, Mysuru

External guide

Mr. Ganesh Naik
Project officers
Shri Kshethra Dharmasthala
Rural Department Project BC
Trust, Hullahalli

Submitted To

University of Mysuru

In Partial Fulfilment of Aware of Post Graduate Degree In Commerce (M. Com)

Department of Commerce P.G Centre – M.com

Sarada Vilas College, Mysuru

Phone: 0821-2332479, Fax: 0821-2330221

E-mail: principal@saradavilas.com

website: www.saradavilas.com



SARADA VILAS EDUCATIONAL INSTITUTIONS (Regd.)

SARADA VILAS COLLEGE

Krishnamurthypuram, Mysore - 570 004 Karnataka

Affiliated to University of Mysore

Re accredited by NAAC with B+ grade (CGPA: 2.70)



Date : 5/9/23

CERTIFICATION

This is to certify that **Ms. Suma M K (Reg. No. P01BG21C 0005)** is a bonafide student of PG Centre-M. Com, Sarada Vilas College, studying M. Com final year in the academic year 2022-2023. As a part of her final examination M. Com she has prepared a project report "**Shri Kshethra Dharmasthala rural development project – A Review with an intention of analysing the impact of projects an Economic Culture and Spiritual aspects as rural people**" under the guidance of Mrs. Pragathi.K Assistant Professor, PG Centre-M. Com, Sarada Vilas College, Mysuru. I certify that, this project work is her original work and not presented to any other University / Institution for award of any Degree/Diploma.

Dean

Dean

Commerce and Busi. Admn.

Sarada Vilas College

Mysuru-570 004

Principal

Dr. M Davita

M.Sc. M.Phil. Ph.D.

Principal

Sarada Vilas College,

Krishnamurthypuram, Mysuru



ವೀರೇಂದ್ರ ಹೆಗ್ಡೆಯವರು
ಅಧ್ಯಕ್ಷರು

॥ ಓಂ ಶ್ರೀ ಮಂಜುನಾಥಾಯ ನಮಃ ॥
ಶ್ರೀ ಕ್ಷೇತ್ರ ಧರ್ಮಸ್ಥಳ ಗ್ರಾಮಾಭಿವೃದ್ಧಿ ಯೋಜನೆ ಬಿ ಸಿ ಟ್ರಸ್ಟ್ (೦)

ಹುಲ್ಲಹಳ್ಳಿ ಯೋಜನಾ ಕಛೇರಿ

ಶಾಶ್ವತ ಅಭಿವೃದ್ಧಿಗಾಗಿ ಸಮಗ್ರ ಯೋಜನೆ

DATE-01.08.2023

CERTIFICATE

This is to certificate that Ms Suma M K (Ref No P01BG21C0005) studying M.Com in Sharada vilas collage, Mysore has done Project Work **"SHREE KSHETRA DHARMASTHALA RURAL DEVELOPMENT PROJECT® -A Review with an Intention of analyzing the impact of projects an Economic, Cultural and Spiritual aspect as rural people"**

From 01.03.2023 to 01.08.2023 in our Organization Succussfully.

We wish her al the very best for her future endeavors

GANESH NAIK

PROJECT OFFICER

Project Officer
Shri Kshethra Dharmasthala R
Development Project BC Trust
Hullahalli

Project Report

"ASSESSMENT OF PROFITABILITY STATUS OF THE SAMRUDDHI CREDIT
CO-OPERATIVE SOCIETY LIMITED, BHARATHINAGARA, MANDYA, USING
THE RATIO"

Submitted by

SPHOORTHI S C

Reg. No: P01BG21C0034

Internal Guide

Mrs. PRAGATHI. K

Assistant professor

Department of Commerce

PG Centre-M.Com

Sarada Vilas College

Mysuru.

External Guide

Mrs. CHIKKATHAYAMMA

Secretary

SAMRUDDHI credit

Co-operative society

limited, Bharathinagara,

Maddur taluk, mandya

Submitted to

University of Mysore

In partial fulfillment of award of Post Graduate Degree in Commerce (M.Com),

Department of Commerce PG, Centre-M.Com

SARADA VILAS COLLEG, MYSURU.



SARADA VILAS EDUCATIONAL INSTITUTIONS (Regd.)

SARADA VILAS COLLEGE

Krishnamurthypuram, Mysore - 570 004 Karnataka

Affiliated to University of Mysore

Re accredited by NAAC with B+ grade (CGPA: 2.70)



Date : 05/09/2023

CERTIFICATION

This is to certify that **Ms. Sphoorthi S C (Reg. No. P01BG21C0034)** is a bonafide student of PG Centre-M.Com, Sarada Vilas College, studying M.Com final year in the academic year 2022-2023. As a part of her final examination M. Com she has prepared a project report " **Assessment of profitability status of the SAMRUDDHI credit co-operative society limited, Bharathinagara, Mandya, Using the ratio.**" under the guidance of Mrs. Pragathi.K Assistant Professor, PG Centre-M.Com, Sarada Vilas College, Mysuru. I certify that, this project work is her original work and not presented to any other University / Institution for award of any Degree/Diploma.

Dean

Dean
Commerce and Busi. Admin.
Sarada Vilas College
Mysuru - 570 004

Principal

Dr. M Devika
M.Sc., M.Phil., Ph.D.
Principal
Sarada Vilas College,
Krishnamurthypuram, Mysuru



ಸಮೃದ್ಧಿ ಪತ್ರನ ಸಹಕಾರ ಸಂಘ ನಿಯಮಿತ

SAMRUDDHI CREDIT CO-OPERATIVE SOCIETY LIMITED

(REG NO: 39/ R.S.R./45614/2014-15)

18 GUDI Street, BHARATHINAGARA (K.M.DODDI), MADDUR TALUK, MANDYA District. – 571422

CERTIFICATE

This is to certify that MS. SPHOORTHI S C (Reg. No: P01BG21C0034) of SARADA VILAS COLLEGE, MYSURU, affiliated to university of MYSURU has done project work on "Assessment of profitability status of SAMRUDDHI credit co-operative society limited BHARATHINAGARA, MANDYA, Using ratio" From 01/03/2023 to 29/04/2023. During his project work in our co-operative society, we found her character and conduct to be good. We wish her success in life and career.



C. Alekhathe
ಮುಖ್ಯ ಕಾರ್ಯನಿರ್ವಾಹಕ ಅಧಿಕಾರಿ
ಸಮೃದ್ಧಿ ಪತ್ರನ ಸಹಕಾರ ಸಂಘ ನಿಯಮಿತ
ಭಾರತೀ ಭಾಗ, ಮದ್ದೂರು ತಾಲ್ಲೂಕು.
SECRETARY
SAMRUDDHI credit

Co-operative society limited

BHARATHINAGARA (K. M. DODDI)

MADDUR TALUK MANDYA

District – 571422

Date: 02/08/2023

Place: BHARATHINAGARA

PROJECT REPORT

**“A STUDY ON CUSTOMER SATISFACTION TOWARDS PRASAD GAS AGENCY
IN MYSURU”**

SUBMITTED BY

YASHASWINI J P

Register No: P01BG21C0053

EXTERNAL GUIDE

Mr. Krishnamurthy

Manager Prasad Gas Agency,
Mysuru

INTERNAL GUIDE

Mrs. Pragathi.K

Assistant professor
PG Centre – M. Com

SUBMITTED TO

University of Mysuru

In partial fulfilment of award of post Graduate Degree in Commerce (M. Com)

Department of Commerce PG centre – M. Com

Sarada Vilas College, Mysuru.



SARADA VILAS EDUCATIONAL INSTITUTIONS (Regd.)

SARADA VILAS COLLEGE

Krishnamurthypuram, Mysore – 570 004 Karnataka

Affiliated to University of Mysore

Re accredited by NAAC with B+ grade (CGPA: 2.70)



Date :

CERTIFICATION

This is to certify that Ms. Yashaswini J P (Reg. No. P01BG21C0053) is a bonafide student of PG Centre-M.Com, Sarada Vilas College, studying M.Com final year in the academic year 2022-2023. As a part of her final examination M.Com she has prepared a project report "A Study on Customer Satisfaction towards Prasad Gas Agency in Mysuru." under the guidance of Mrs Pragathi.K Assistant Professor, PG Centre-M.Com, Sarada Vilas College, Mysuru. I certify that, this project work is her original work and not presented to any other University / Institution for award of any Degree/Diploma.

Dean

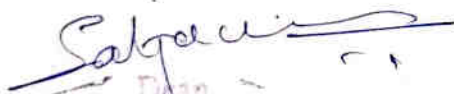
Dean
Commerce and Busi. Admn.
Sarada Vilas College
Mysuru, 570 004



Principal
Dr. M Devika
M.Sc., M.Phil., Ph.D.
Principal
Sarada Vilas College,
Krishnamurthypuram, Mysuru



Certificate

This is to certify that Ms. Yashaswini J P (Reg. no P01BG21C0053) studying final year M.com in Sarada Vilas College, PG Centre, Mysuru, affiliated to University of Mysore.

She has successfully completed her "Project Work" on "Topic: A study on Customer satisfaction towards Prasad Gas Agency, Mysuru".

We wish her all the success in her future endeavour.

For PRASAD GAS SERVICE

MANAGER
Manager

Place: Mysuru

Project Report

On

**“An Analytical Study on the Supply and Demand for Milk Variants Produced by
CHAMUL”**

Submitted by

Bhavana A M

Reg. No: P01BG21C0046

Internal Guide

Mrs. Pragathi K

Assistant Professor

Department of Commerce

PG Centre –M.Com

Sarada Vilas College, Mysuru

External Guide

Mr. A. Shivukumar

Department of marketing

Chamul Ltd

Chamarajanagar district, Kuderu

Submitted to

University of Mysore

In partial fulfilment of award of Post Graduate Degree in Commerce (M. Com)

Department of Commerce PG Centre – M. Com

Sarada Vilas College, Mysuru.

2022-2023



SARADA VILAS EDUCATIONAL INSTITUTIONS (Regd.)

SARADA VILAS COLLEGE

Krishnamurthypuram, Mysore – 570 004 Karnataka

Affiliated to University of Mysore

Re accredited by NAAC with B+ grade (CGPA: 2.70)



Date : 05/09/2023

CERTIFICATION

This is to certify that **Ms. Bhavana AM (Reg. No. P01BG21C0046)** is a bonafide student of PG Centre-M.Com, Sarada Vilas College, studying M.Com final year in the academic year 2022-2023. As a part of her final examination M. Com she has prepared a project report " **An Analytical Study on the Supply and Demand for Milk Variants Produced by CHAMUL Ltd**" under the guidance of Mrs. Pragathi.K Assistant Professor, PG Centre-M.Com, Sarada Vilas College, Mysuru. I certify that, this project work is her original work and not presented to any other University / Institution for award of any Degree/Diploma.

Dean 
Dean
Commerce and Busi, Adm-
Sarada Vilas College
Mysuru-570 004

Principal
Dr. M Devika
M.Sc., M.Phil., Ph.D.
Principal
Sarada Vilas College,
Krishnamurthypuram, Mysuru

SARADA VILAS EDUCATIONAL INSTITUTIONS (Regd.)

SARADA VILAS COLLEGE

Krishnamurthypuram, Mysore – 570 004 Karnataka

Affiliated to University of Mysore

Re accredited by NAAC with B+ grade (CGPA: 2.70)



Date : 05/09/2023

CERTIFICATION

This is to certify that **Ms. Bhavana AM (Reg. No. P01BG21C0046)** is a bonafide student of PG Centre-M.Com, Sarada Vilas College, studying M.Com final year in the academic year 2022-2023. As a part of her final examination M. Com she has prepared a project report " **An Analytical Study on the Supply and Demand for Milk Variants Produced by CHAMUL Ltd**" under the guidance of Mrs. Pragathi.K Assistant Professor, PG Centre-M.Com, Sarada Vilas College, Mysuru. I certify that, this project work is her original work and not presented to any other University / Institution for award of any Degree/Diploma.

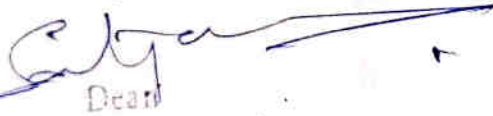
Dean 
Dean
Commerce and Busi, Adm-
Sarada Vilas College
Mysuru-570 004

Principal
Dr. M Devika
M.Sc., M.Phil., Ph.D.
Principal
Sarada Vilas College,
Krishnamurthypuram, Mysuru

A
Project Report
On

“Product promotion activities of Arjun motors. It’s impact on buyers and effects in the last 3 years.”

Submitted By

Harish H M

Reg. No. P01BG21C0018

Internal Guide

Pragathi K

Assistant Professor

Department of commerce

P. G Centre -M. Com

Sarada Vilas College, Mysuru

External Guide

Mukesh Kumar

Proprietor

Arjun Motors

Mysore

Submitted To

University of Mysore

In partial fulfilment of award of Post Graduate Degree in Commerce (M. Com)

Department of Commerce P. G Centre – M. Com

Sarada Vilas College, Mysuru



SARADA VILAS EDUCATIONAL INSTITUTIONS (Regd.)

SARADA VILAS COLLEGE

Krishnamurthypuram, Mysore – 570 004 Karnataka
Affiliated to University of Mysore
Re accredited by NAAC with B+ grade (CGPA: 2.70)



Date : 5/09/23

CERTIFICATION

This is to certify that **Mr. Harish H M (Reg. No. P01BG21C0018)** is a bonafide student of PG Centre-M.Com, Sarada Vilas College, studying M.Com final year in the academic year 2022-2023. As a part of his final examination M.Com he has prepared a project report "Product promotion activities of Arjun Motors. it's impact on buyers and effects in the last three years'. under the guidance of Mrs. Pragathi.K Assistant Professor, PG Centre-M.Com, Sarada Vilas College, Mysuru. I certify that, this project work is his original work and not presented to any other University / Institution for award of any Degree/Diploma.

Dean
Commerce and Busi, Admn.
Sarada Vilas College
Mysuru-570 004

Principal
Dr. M Devika
M.Sc., M.Phil., Ph.D.
Principal
Sarada Vilas College
Krishnamurthypuram, Mysuru

ARJUN MOTORS
YAMAHA

Arjun Motors No 937/4, New Kantaraj Urs Road, Lakshmi Puram, Mysore – 570004 (Near:
Balal Circle)

CERTIFICATE

This is to certify that Mr. Harish HM, (P01BG21C0018) studying final year M. Com in Sarada Vilas College, PG Centre, Mysuru, affiliated to University of Mysore.

He done successfully completed his **“Project Work”** on Product Promotion activities of arjun motors. It's impact on buyers and effects in the last 3 years.

We wish all the best for his future endeavor.

For ARJUN MOTORS

Manager

Manager

Place: Mysuru.

ARJUN MOTORS
937/4, New Kantharaj Urs road
Kshempuram, MYSORE-570 004
☎: 0821 4000401/402

PROJECT REPORT

**“A STUDY ON CHANNEL OF DISTRIBUTION KENATH AQUA, JP NAGAR
MYSURU.”**

SUBMITTED BY

Basavalingappa

Register No: P01BG21C0030

EXTERNAL GUIDE

Mr. Surya Gopal

Manager of Kenath Aqua,
JP Nagar
Mysuru

INTERNAL GUIDE

Mrs. Pragathi.K

Assistant professor
PG Centre – M. Com
Sarada Vilas College, Mysuru

SUBMITTED TO

University of Mysuru

In partial fulfillment of award of post Graduate Degree in Commerce (M. Com)
Department of Commerce PG centre – M. Com
Sarada Vilas College, Mysuru.

SARADA VILAS EDUCATIONAL INSTITUTIONS (Regd.)

SARADA VILAS COLLEGE

Krishnamurthypuram, Mysore – 570 004 Karnataka

Affiliated to University of Mysore

Re accredited by NAAC with B+ grade (CGPA: 2.70)



Date : 05/09/23

CERTIFICATION

This is to certify that **Mr. Basavalingappa (Reg. No. P01BG21C0030)** is a bonafide student of PG Centre-M.Com, Sarada Vilas College, studying M.Com final year in the academic year 2022-2023. As a part of his final examination M.Com he has prepared a project report " **A Study on channel of distribution Kenath Aqua, JP Nagar Mysuru.**" under the guidance of Mrs. Pragathi.K Assistant Professor, PG Centre-M. Com, Sarada Vilas College, Mysuru. I certify that, this project work is his original work and not presented to any other University / Institution for award of any Degree/Diploma.

A handwritten signature in blue ink, appearing to read 'S. Prasad'.

Dean

Dean **Commerce and Busi, Admn.**
Sarada Vilas College
Mvsuru-570 004

A handwritten signature in blue ink, appearing to read 'Dr. M. Devika'.

Principal

Dr. M. Devika
M.Sc., M.Phil., Ph.D.
Principal
Sarada Vilas College,
Krishnamurthypuram, Mysuru



Kenath Aqua, JP Nagar, Mysuru.

CERTIFICATE

This is to certify that Mr. Basavalingappa, (reg no P01BG21C0030) studying final year M.com in Sarada Vilas College, PG Centre, Mysuru, affiliated to university of Mysore.

He done successfully completed his "**Project Work**" on "A Study on channel of distribution of Kenath Aqua, JP Nagar, Mysuru".

We wish all the best for his future endeavor.

KENATH AQUA
SIDDAPPAJI ENTERPRISES
• 14/B, Industria
3rd Stage, Mysuru

Manager

Place: Mysuru

A

Project report

On

**“Trading activity of choice equity broking private limited in
Connection with shares and debentures”**

SUBMITTED BY

MOHAN WADEYAR. M

P01BG21C0032

INTERNAL GUIDE

Pragathi K

Asst. Professor

Department of Commerce

PG Centre -M. Com

Sarada Vilas College

Mysuru

EXTERNAL GUIDE

Mr. Chandrashekar Murthy G

Manager-sales

choice equity broking Pvt Ltd

Submitted To

University of Mysuru

In partial fulfillment of award of Post Graduate Degree in Commerce (M. Com)

Department of Commerce P.G Centre-M.com

Sarada Vilas College, Mysuru

Phone: 0821-2332479, Fax: 0821-2330221

E- mail: principal@saradavilas.com

website: www.saradavilas.com



SARADA VILAS EDUCATIONAL INSTITUTIONS (Regd.)

SARADA VILAS COLLEGE

Krishnamurthypuram, Mysore – 570 004 Karnataka

Affiliated to University of Mysore

Re accredited by NAAC with B+ grade (CGPA: 2.70)



Date : 05/09/2023

CERTIFICATION

This is to certify that **Mr. Mohan wadeyar M (Reg. No. P01BG21C0032)** is a bonafide student of PG Centre-M.Com, Sarada Vilas College, studying M.Com final year in the academic year 2022-2023. As a part of his final examination M.Com she he prepared a project report **“Trading activity of equity choice broking private limited in Connection with shares and Debentures”** under the guidance of Mrs. Pragathi.K Assistant Professor, PG Centre-M.Com, Sarada Vilas College, Mysuru. I certify that, this project work is his original work and not presented to any other University / Institution for award of any degree/Diploma.

Dean

Dean
Commerce and Busi, Admn.
Sarada Vilas College
Mysuru-570 004

Principal

Dr. M Devita
M.Sc, M.Phil., Ph.D.
Principal
Sarada Vilas College,
Krishnamurthypuram, Mysuru

CERTIFICATE

This is to certify that **Mr.Mohan wadeyar M (reg. no PO1BG21C0031)** IV semester M.Com Student of Sarada Vilas College, PG Centre, Mysore, affiliated to University of Mysore has undergone the project work on

“Trading activity of Choice Equity Broking private limited in Connection with shares and debentures”

he has successfully worked under my guidance.

We wish her all the success in her future endeavor.

For choice equity broking private limited

Manager

Place: Mysuru

PROJECT REPORT

On

**“A COMPARATIVE STUDY OF REVENUE GENERATED BY
DIFFERENT PRODUCTS PRODUCED BY CHAMUL LTD”**

SUBMITTED BY

BHARATH KUMAR V

Register No: P01BG21C0027

UNDER THE GUIDE OF

EXTERNAL GUIDE

Mrs. PRAGATHI.K

Assistance professor

Department of commerce

PG Centre – M. Com

Sarada vilas college, Mysuru

INTERNAL GUIDE

Mr. ANAND KUMAR HS

Department of finance

Chamul Ltd

Chamarajanagar district, Kuderu

SUBMITTED TO

UNIVERSITY OF MYSURU

In partial fulfilment of award of Post Graduate in Commerce (M. Com)

Department of Commerce and Business Administration

PG Centre- M. Com

Sarada Vilas College, Mysuru

2022-2023



SARADA VILAS EDUCATIONAL INSTITUTIONS (Regd.)

SARADA VILAS COLLEGE

Krishnamurthypuram, Mysore – 570 004 Karnataka

Affiliated to University of Mysore

Re accredited by NAAC with B+ grade (CGPA: 2.70)



Date : 05/09/2023

CERTIFICATION

This is to certify that **Mr. Bharath Kumar V (Reg. No. P01BG21C0027)** is a bonafide student of PG Centre-M.Com, Sarada Vilas College, studying M. Com final year in the academic year 2022-2023. As a part of his final examination M.Com he has prepared a project report " **A Comparative Study of Revenue Generated by different Products Produced by CHAMUL Ltd**" under the guidance of Mrs. Pragathi.K Assistant Professor, PG Centre-M.Com, Sarada Vilas College, Mysuru. I certify that, this project work is his original work and not presented to any other University / Institution for award of any Degree/Diploma.

Dean

Dean

Commerce and Busi, Admn.
Sarada Vilas College
Mysuru-570 004

Principal

Dr. M Devika

M.Sc, M.Phil, Ph.D.

Principal

Sarada Vilas College,
Krishnamurthypuram, Mysuru



ಚಾಮರಾಜನಗರ ಜಿಲ್ಲಾ ಸಹಕಾರಿ ಹಾಲು ಉತ್ಪಾದಕರ ಸಂಘಗಳ ಒಕ್ಕೂಟ ನಿ.
Chamarajanagar Dist. Co-operative Milk Producer's Societies Union Ltd.



 FSSC 22000

No.204-1: Chamul: Admin: 2023

Date 01.08.2023

CERTIFICATE

TO WHOMSOEVER IT MAY CONCERN

This is to certify that Bharath Kumar V student studying Final Year Master of Commerce (M.Com) at Sarada Vilas College, Mysore has done the Project on the topic of "A Comparative Study of Revenue Generated by Different Products Produced by CHAMUL Ltd" practice in our organization from 01.05.2023 to 31.05.2023.

Manager (Admin)
Manager (Admin)
Chamarajanagar Dist. Co-op
Milk Union Ltd., Kuderu
Chamarajanagar-571 316



ಕುದೇರು ಗ್ರಾಮ ಮತ್ತು ಅಂಚೆ, ಸಂತೇಮರಳ್ಳಿ ಹೋಬಳಿ, ಚಾಮರಾಜನಗರ-571 316.

Kuderu Village & Post, Santhemarahalli Hobli, Chamarajanagar-571 316

E-mail : admnchamul@gmail.com, purchamul@gmail.com, chamulmis@gmail.com

Ph : 08226-234848 Website : www.chamul.co.in



Project Report

**“A STUDY ON THE CHALLENGES FACED BY COFFEE CURING WORKS WITH
SPECIAL REFERENCE TO HIGH RANGE COFFEE CURING PVT LTD IN
PERIYAPATANA”**

Submitted by

MOHITHA M

Reg No: P01BG21C0012

Internal Guide

**Ms. Pragathi K
Asst. Professor
Department of commerce
PG Centre- M. Com
Sarada Vilas College, Mysore**

External Guide

**Ms. Pavithra
Accountant
High Range Coffee
Curing Pvt Ltd
Periyapatana**

Submitted to

University of Mysuru

In partial fulfilment of award of post Graduate Degree in Commerce (M. Com)

Department of Commerce P. G Centre- M. Com

Sarada Vilas college Mysuru



SARADA VILAS EDUCATIONAL INSTITUTIONS (Regd.)

SARADA VILAS COLLEGE

Krishnamurthypuram, Mysore – 570 004 Karnataka

Affiliated to University of Mysore

Re accredited by NAAC with B+ grade (CGPA: 2.70)



Date : 05/09/2023

CERTIFICATION

This is to certify that **Ms. Mohitha M (Reg. No. P01BG21C0012)** is a bonafide student of PG Centre-M.Com, Sarada Vilas College, studying M.Com final year in the academic year 2022-2023. As a part of her final examination M. Com she has prepared a project report " **A Study on the challenges faced by Coffee Curing Works with special reference to High Range Coffee Curing Pvt Ltd in Piriapatna.**" under the guidance of Mrs. Pragathi.K Assistant Professor, PG Centre-M.Com, Sarada Vilas College, Mysuru. I certify that, this project work is her original work and not presented to any other University / Institution for award of any Degree/Diploma.

Dean

Dean

Commerce and Busi, Admn.
Sarada Vilas College
Mysuru-570 004

Principal

Dr. M Devika

M.Sc., M.Phil., Ph.D.

Principal

Sarada Vilas College,
Krishnamurthypuram, Mysuru



HIGH RANGE COFFEE CURING PVT LTD

B.M ROAD, ABBUR VILLAGE, PERIYAPATNA-571107

GSTIN: 29AAACH8173L1Z2

CERTIFICATE

TO WHOM SO EVER CONCERN

It is to certify that Ms. Mohitha M (REG NO:P01BG21C0012) a student of Sarada College Mysore. Has successfully undergone the Project work under the valuable guidance of Ms. Pavithra, Accountant, High Range Coffee Curing Pvt Ltd, Abbur village, B M road Abbur, Periyapatna. From 1st March 2023 to 29th April 2023. The project has been completed successfully to our satisfaction, her conduct during the course of the project was good, and we wish her all the best in her career.



High Range Coffee Curing Ltd.

Asst. Manager



A
Project Report
on
**“A STUDY ON STRESS MANAGEMENT IN MSME
ORGANIZATION WITH SPECIAL REFERENCE TO
SSV ENTERPRISES”**

Submitted by
MEGHANA S
(P01BG21C0010)

Internal Guide

Mrs. Pragathi K
Assistant Professor
Department of Commerce
P.G Centre-M.Com
Sarada Vilas College, Mysuru

External Guide

Mr. Venkatesh S
Proprietor
SSV Enterprises
K R Mohalla Mysuru

Submitted to,

University of Mysore

In partial fulfillment of award of Post Graduate Degree in Commerce (M.Com)

Department of Commerce PG Centre – M.Com

Sarada Vilas College, Mysuru.

2023



SARADA VILAS EDUCATIONAL INSTITUTIONS (Regd.)

SARADA VILAS COLLEGE

Krishnamurthypuram, Mysore – 570 004 Karnataka

Affiliated to University of Mysore

Re accredited by NAAC with B+ grade (CGPA: 2.70)



Date :

CERTIFICATION

This is to certify that **Ms. Meghana S (Reg. No. P01BG21C0010)** is a bonafide student of PG Centre-M.Com, Sarada Vilas College, studying M.Com final year in the academic year 2022-2023. As a part of her final examination M.Com she has prepared a project report "**A Study on stress management in MSME organization with special reference to SSV Enterprises**" under the guidance of Mrs. Pragathi.K Assistant Professor, PG Centre-M.Com, Sarada Vilas College, Mysuru. I certify that, this project work is her original work and not presented to any other University / Institution for award of any Degree/Diploma.

Dean

Dean
Commerce and Busi. Admin.
Sarada Vilas College
Krishnamurthypuram, Mysuru

Principal

Dr. M Devika
M.Sc., M.Phil., Ph.D.
Principal
Sarada Vilas College,
Krishnamurthypuram, Mysuru



S.S.V ENTERPRISES

#301, kshethriya road, road thogari beedi, next to kollapurada mahalakshmi temple, K.R Mohalla
Mysuru - 24 PH-9591577107,6360966717

DATE.....

CERTIFICATE

This is to certify that **Ms. MEGHANA.S (P01BG21COO10)** IV semester M. Com student of Sarada Vilas college PG Centre, Mysore affiliated to university of Mysore has undergone the project work on **"A STUDY ON STRESS MANAGEMENT IN MSME ORGANIZATION WITH SPECIAL REFERENCE TO S.S.V ENTERPRISES"** she has successfully worked under the guidance of Mr. Venkatesh.S, Proprietor, Mysore District.

We wish her all the success in her future endeavour.

Place: Mysore

Date:

SSV ENTERPRISES
301, Kshethriya Road, Thogari Beedi
Next to Kollapurada Mahalakshmi Temple
K.R. Mohalla, Mysuru - 24

Proprietor
Venkatesh.S

A

Project Report

On

**“A STUDY ON IMPACT OF ADVERTISEMENT ON TWO WHEELERS
VEHICLES IN SRI LAKSHMI MOTORS NANJANGUDU.”**

Submitted By

SACHIN. M

(Reg. No. P01BG21C0042)

Internal Guide

Pragathi K

Assistant Professor

Department of commerce

P. G Centre -M. Com

Sarada Vilas College, Mysuru.

External Guide

C.P. Mahesh

Proprietor

Sri Lakshmi Motors

Nanjangudu.

Submitted To

University of Mysore

In partial fulfilment of award of Post Graduate Degree in Commerce (M. Com)

Department of Commerce P. G centre – M. Com

Sarada Vilas College, Mysuru.



SARADA VILAS EDUCATIONAL INSTITUTIONS (Regd.)

SARADA VILAS COLLEGE

Krishnamurthypuram, Mysore – 570 004 Karnataka

Affiliated to University of Mysore

Re accredited by NAAC with B+ grade (CGPA: 2.70)



Date : 05/09/2023

CERTIFICATION

This is to certify that **Mr. Sachin M (Reg. No. P01BG21C0042)** is a bonafide student of PG Centre-M.Com, Sarada Vilas College, studying M.Com final year in the academic year 2022-2023. As a part of his final examination M. Com he has prepared a project report **“A Study on impact of advertisement on two wheelers vehicles in Sri Lakshmi Motors Nanjangudu.”** under the guidance of Mrs. Pragathi.K Assistant Professor, PG Centre-M.Com, Sarada Vilas College, Mysuru. I certify that, this project work is his original work and not presented to any other University / Institution for award of any Degree/Diploma.

Dean

Dean

Commerce and Busi, Admn.

Sarada Vilas College

Mysuru-570 004

Principal
Dr. M Devika

M.Sc., M.Phil., Ph.D.

Principal

Sarada Vilas College,
Krishnamurthypuram, Mysuru

Ahesh

for

221-226600

99860 53998

SRI LAKSHMI MOTORS

Authorised Dealer (Two Wheelers)

TVS Motor Company
Sales & Service, Spares



As No. 7461/A-7174/A, Ooty-Mysore Road, NANJANGUD - 571 301
srilakshnimotorsn@gmail.com

CERTIFICATE

Date :

This is to certify that Mr. Sachin M. (reg.P01BG21C0042) IVth semester M.Com., Student of Sharada Vilas College, Mysore, affiliated to University of Mysore has undergone the project work on "A STUDY ON IMPACT OF ADVERTISEMENT ON TWO WHEELER VEHICLES" IN SRI LAKSHMI MOTORS, NANJANGUDU.

He has successfully worked under my guidance.

We wish him all the success in his future endeavour.

Regards,

For SRI LAKSHMI MOTORS

Ahesh
For Sri Lakshmi Motors,

Place: Nanjangudu.

A

Project report

On

**“MARKETING STRATERGIES -AN ANALYTICAL STUDY OF ITS
APPLICATION IN KENTUCKY FRIED CHICKEN COMPANY LIMITED
MYSORE BRANCH”**

Submitted By

K. RATHISH KUMAR

Reg. No. P01BG21C00 29

Internal Guide

Pragathi K

Assistant Professor

Department of commerce

P. G Centre -M. Com SVC, Mysuru

External Guide

Mr. Dhanush.S

Manager of KFC

Dr. Raj Kumar Road

Mysore

Submitted To

University of Mysore

In partial fulfilment of award of Post Graduate Degree in Commerce (M. Com)

Department of Commerce P. G centre – M. Com

Sarada Vilas College, Mysuru

SARADA VILAS EDUCATIONAL INSTITUTIONS (Regd.)

SARADA VILAS COLLEGE

Krishnamurthypuram, Mysore – 570 004 Karnataka

Affiliated to University of Mysore

Re accredited by NAAC with B+ grade (CGPA: 2.70)



Date : 05/09/2023

CERTIFICATION

This is to certify that **Mr. K. Rathish Kumar (Reg. No. P01BG21C0029)** is a bonafide student of PG Centre-M.Com, Sarada Vilas College, studying M.Com final year in the academic year 2022-2023. As a part of his final examination M. Com he has prepared a project report **“Marketing strategies – An analytical study of its application in Kentucky Fried Chicken Company limited, Mysuru branch”** under the guidance of Mrs. Pragathi.K Assistant Professor, PG Centre-M.Com, Sarada Vilas College, Mysuru. I certify that, this project work is his original work and not presented to any other University / Institution for award of any Degree/Diploma.

Dean

Dean
Commerce and Busi, Admn.
Sarada Vilas College
Mysuru-570 004

Principal

Dr. M Devika
M.Sc., M.Phil., Ph.D.
Principal
Sarada Vilas College,
Krishnamurthypuram, Mysuru



Certificate

This is to certify that Mr. K. Rathish kumar (reg. no P01BG21C0029) IV semester M Com Student of Sharada Vilas College, PG Centre, Mysore, affiliated to University of Mysore has undergone the project work on

"Marketing strategies -an analytical study of its application in Kentucky fried chicken company limited Mysore branch"

He has successfully worked under my guidance.

We wish him all the success in his future endeavor.

For Dhanush.S and KFC

Dhanush.S.

KFC Dr. Raj Kumar Road Mysore 33/A2, Dr. Raj Kumar Road, Naziabad Mohalla, Mysore, POS: Karnataka
GSTIN No.: 29AABCD5534A1Z1

Manager

Place: Mysore

Project Work

**“A STUDY ON CUSTOMER RETENTION STRATEGY ON
GANESHA FOOD PRODUCTS”**

Submitted by

HARSHITHA N

Reg No: P01BG21C0017

Internal Guide

Mrs. Pragathi. K
Assistant Professor
P.G Centre- M. Com
Sarada Vilas College, Mysuru

External Guide

Mr. Guru Prasad
Sales General Manager
Ganesha Food Products
Mysuru

Submitted to

University of Mysore
In partial fulfilment of award of Post Graduate Degree in Commerce (M. Com)
Department of Commerce P. G Centre- M. Com
Sarada Vilas College,



SARADA VILAS EDUCATIONAL INSTITUTIONS (Regd.)

SARADA VILAS COLLEGE

Krishnamurthypuram, Mysore – 570 004 Karnataka

Affiliated to University of Mysore

Re accredited by NAAC with B+ grade (CGPA: 2.70)



Date: 5/9/23

CERTIFICATION

This is to certify that Ms. Harshitha N (Reg. No. P01BG21C0017) is a bonafide student of PG Centre-M.Com, Sarada Vilas College, studying M.Com final year in the academic year 2022-2023. As a part of her final examination M. Com she has prepared a project report " A Study on Customer Retention Strategy on Ganesh Food Products Company Ltd" under the guidance of Mrs. Pragathi.K Assistant Professor, PG Centre-M.Com, Sarada Vilas College, Mysuru. I certify that, this project work is her original work and not presented to any other University / Institution for award of any Degree/Diploma.

Dean

Dean

Commerce and Busi. Admn.
Sarada Vilas College
Mysuru-570 004

Principal

Dr. M Devika

M.Sc., M.Phil., Ph.D.

Principal

Sarada Vilas College,
Krishnamurthypuram, Mysuru

Manufacturers of :
PASTAS, VERMICELLI, AND
OTHER FOOD ITEMS



No. 26
Bhagavathi Food Industrial Area Metagalli
Mysore - 570 016
Phone: 510580, 519883. Resi. 511426

Date : 02/08/2023

CERTIFICATE

This is to certify that Ms. HARSHITHA. N (Reg no P01BG21C0017) student of M com studying in sharada vias collage P G Center Mysore Has successfully completed about project of food product manufacturing from 15/5/2023 to 22/5/23 under the guidance of Mr Guru Prasad

During the period of her project program with our company she had found very diligent in her work

We wish her for every success in her future

Authorised signature

For Ganesha Food Products
Naranda. N. N.
Managing Partner

A
Project Report
On
**“A Study on recruitment procedure in Mandovi Motors Pvt Ltd Siddartha
Nagar Mysuru.”**

Submitted By
MAHESH KUMAR. S
Reg No: P01BG21C0043

Internal Guide

Pragathi. K
Assistant professor
Department of Commerce
PG Centre M. Com
Sarada Vilas College
Mysuru.

External Guide

Naveen. S
Chief Operating Officer
Mandovi Motors
Private limited
Mysuru.

Submitted To

University of Mysore

In partial fulfilment of award of Post Graduate Degree in Commerce (M. Com)
Department of Commerce P. G Centre M. Com
Sarada Vilas College, Mysuru

Phone: 0821-2332479, Fax: 0821-2330221

E- mail: principal@saradavilas.com

website: www.saradavilas.com

SARADA VILAS EDUCATIONAL INSTITUTIONS (Regd.)

SARADA VILAS COLLEGE

Krishnamurthypuram, Mysore – 570 004 Karnataka

Affiliated to University of Mysore

Re accredited by NAAC with B+ grade (CGPA: 2.70)



Date : 05 / 09 / 2023

CERTIFICATION

This is to certify that **Mr. Mahesh Kumar S (Reg. No. P01BG21C0043)** is a bonafide student of PG Centre-M.Com, Sarada Vilas College, studying M.Com final year in the academic year 2022-2023. As a part of his final examination M. Com he has prepared a project report **“A Study on recruitment procedure in Mandovi Motors Pvt Ltd Siddartha Nagar Mysuru.”** under the guidance of Mrs. Pragathi.K Assistant Professor, PG Centre-M.Com, Sarada Vilas College, Mysuru. I certify that, this project work is his original work and not presented to any other University / Institution for award of any Degree/Diploma.

A handwritten signature in blue ink, appearing to read 'Sathya', with a long horizontal stroke extending to the right.

Dean

Dean Commerce and Busi, Admn.
Sarada Vilas College
Mysuru-570 004

A handwritten signature in blue ink, appearing to read 'Dr. M. Devika', with a long horizontal stroke extending to the right.

Principal

Dr. M Devika
MR. M.P.O.S.D
Principal
Sarada Vilas College,
Krishnamurthypuram, Mysuru



Mandovi Motors #182/145/C, Bannur Road, Siddhartha Nagar, Mysore –
570011,

Phone: 4009800.

CERTIFICATE

This is to certify that Mr. Mahesh Kumar s, (P01BG21C0043) studying final year M.com in Sarada Vila College, PG Centre, Mysuru, affiliated to University of Mysore.

He done successfully completed his “Project Work” on “A Study on the recruitment procedure in Mandovi Motors Pvt Ltd, Mysore”.

We wish all the best for his future endeavour.

MANDOVI MOTORS PRIVATE LIMITED
182/145/C, Bannur Road,
Siddharthanagar, MYSORE - 570 011
☎ : 4009800

Manager

Place: Mysuru

Project Work

**“A STUDY ON 7P’S OF MARKETING MIX AND
IT’S APPLICATION IN SANGEETHA MOBILE PVT LTD, HUNSUR”.**

Submitted by

LAVANYA. H.Y

Reg No: P01BG21C0038

Internal Guide

Ms. Arpitha. K

Assistant Professor

P.G Centre- M. Com

Sarada Vilas College, Mysuru

External Guide

Mr. Preetham Raj

Assistant Manager

Sangeetha Mobile Pvt Ltd

Hunsur

Submitted to

University of Mysore

In partial fulfilment of award of Post Graduate Degree in Commerce (M. Com)

Department of Commerce P. G Centre- M. Com

Sarada Vilas College, Mysuru

Phone: 0821-2332479, Fax: 0821-2330221

E-mail: principal@saradavilas.com

website: www.saradavilas.com

SARADA VILAS EDUCATIONAL INSTITUTIONS (Regd.)

SARADA VILAS COLLEGE

Krishnamurthypuram, Mysore - 570 004 Karnataka

Affiliated to University of Mysore

Re accredited by NAAC with B+ grade (CGPA: 2.70)





Date :

CERTIFICATION

This is to certify that **Ms. Lavanya H Y (Reg.No. P01BG21C0038)** is a bonafide student of PG Centre-M. Com, Sarada Vilas College, studying in the final year M.Com of the academic 2022-23. As a partial fulfilment of her final examination M.Com, she has prepared a project report **"A STUDY ON 7P'S OF MARKETING MIX AND IT'S APPLICATION IN SANGEETHA MOBILES PVT LTD, HUNSUR"** under the guidance of Ms. Arpitha K, Assistant Professor, PG Centre-M. Com, Sarada Vilas College, Mysuru. I certify that, this project work is her original work and not presented to any other University / Institution for award of any Degree/Diploma.

Dean

Dean
Commerce and Busi, Admn.
Sarada Vilas College
Mysuru-570 004

Principal
Dr. M. Devika
M.Sc., M.Phil., P.D.
Principal
Sarada Vilas College,
Krishnamurthypuram, Mysuru



Sangeetha Mobiles Pvt Ltd – Hunsur -2. Near: #1472, SS Complex, Bazar Road, Hunsur -
571105

CERTIFICATE

This is to certify that Ms. Lavanya HY, (reg. no P01BG21C0038) studying final year M.com in Sarda Vilas College, PG Centre, Mysuru, affiliated to University of Mysore.

She has successfully completed her “**Project Work**” on “7p’s of Marketing Mix it’s application in Sangeetha Mobile Pvt Ltd Hunsur”.

We wish her all the success in her academic endeavor and life.

Assistant Manager

SANGEETHA MOBILES PVT. LTD.
Place: Hunsur

1472, SS Complex
Bazar Road, HUNSUR - 571 105

STORE NO : 8951950627

01/8/23

UNIVERSITY OF MYSORE



**“A Study on Recruitment Process adopted by the Siderforgerossi India Pvt.
Ltd, Mysuru”**

Submitted by:

SUSHMITHA. M

Reg. No: P01BG21C0037

Internal Guide :

Mis. Arpitha K

Assistant Professor

Department of Commerce

P.G Centre –M.Com

Sarada Vilas College. Mysore

External Guide :

Mr. Manu. N

Executive HR

Siderforgerossi India Pvt.

Ltd Metgalli Post

Mysore-570016

Submitted To:

University of Mysore

In partial fulfilment of award of Post Graduate Degree in Commerce (M.Com)

Department of Commerce P.G Centre-M.Com

Sarada Vilas College Mysore



SARADA VILAS EDUCATIONAL INSTITUTIONS (Regd.)

SARADA VILAS COLLEGE

Krishnamurthypuram, Mysore – 570 004 Karnataka

Affiliated to University of Mysore

Re accredited by NAAC with B+ grade (CGPA: 2.70)



Date : 05/09/23

CERTIFICATION

This is to certify that **Ms.Sushmitha M (Reg.No. P01BG21C0037)** is a bonafide student of PG Centre-M. Com, Sarada Vilas College, studying in the final year M.Com of the academic 2022-23. As a partial fulfilment of her final examination M.Com, she has prepared a project report on **"A STUDY ON RECRUITMENT PROCESS ADOPTED BY THE SIDERFORGEROSSO INDIA PVT.LTD, MYSURU"** under the guidance of Ms. Arpitha K, Assistant Professor, PG Centre-M. Com, Sarada Vilas College, Mysuru. I certify that, this project work is her original work and not presented to any other University / Institution for award of any Degree/Diploma.

Dean

Dean
Commerce and Busi. Admn.
Sarada Vilas College
Mysuru-570 004

Principal

Dr. M Devika
M.Sc., M.Phil., Ph.D.
Principal
Sarada Vilas College,
Krishnamurthypuram, Mysuru



SFRG/HRD/23-24/06

Date: 01.08.2023

CERTIFICATE

This is to certify that Ms. SUSHMITHA M Bearing Rge. No P01BG21C0037 Pursuing her Second year, 4th semester M Com at Sarada Vilas College, Mysore has completed her Project Work on "A Study on Recruitment Process adopted by the Siderforgerossi India Private Limited. Mysuru" from 02.05.2023 to 31.07.2023 Under the guidance of Mr.Manu N – Executive –HR , HR & Admin in our Organization.

She has shown interest in learning and her Conduct & Character was good. We wish her all the best for her future endeavors.

For Siderforgerossi India Private Limited.,

Manu N
Executive-HR

Project Report on

**“A STUDY ON HOUSING LOAN FINACING OF DISTRICT
CO-OPERATIVE BANK LTD, MANDYA.”**

Submitted by

Thanuja D
Reg. No: P01BG21C0002

Internal Guide

Ms. Arpitha K

Assistant Professor

Department of Commerce

PG Centre – M. Com

Sarada Vilas College, Mysuru

External Guide

Mr Vasanth Kumar

Manager

Mandya District Co-operative

Bank Ltd Mandya

Submitted to

University of Mysore

In partial fulfilment of award of Post Graduate Degree in Commerce (M. Com)

Department of Commerce PG Centre – M. Com

Sarada Vilas College, Mysuru.



MANDYA DISTRICT CO-OPERATIVE CENTRAL BANK LTD. ಮಂಡ್ಯ ಜಿಲ್ಲಾ ಸಹಕಾರ ಕೇಂದ್ರ ಬ್ಯಾಂಕ್ ನಿ.,

H.O. MANDYA - 571 401. (Karnataka State) Post Box No : 14

ಕೇಂದ್ರ ಕಛೇರಿ : ಮಂಡ್ಯ 571 401 (ಕರ್ನಾಟಕ ರಾಜ್ಯ) ಅಂಚೆ ಪೆಟ್ಟಿಗೆ-14

No. ADM/EST/ 148 /2023-24

Date: 03-08-2023

CERTIFICATE

This is to certify that Ms. Thanuja D Student of M.com. "Sharada Vilas College" Mysore, during the academic year she has prepared a project work entitled "**A Study on the Housing Loan Financing of District Co-Operative Bank Ltd., Mandya**" with special reference to Mandya District Co-operative Central Bank Ltd., Mandya from 26-04-2023 to 01-08-2023.

She has collected necessary information of project work.

Chief Executive Officer



SARADA VILAS EDUCATIONAL INSTITUTIONS (Regd.)

SARADA VILAS COLLEGE

Krishnamurthypuram, Mysore – 570 004 Karnataka

Affiliated to University of Mysore

Re accredited by NAAC with B+ grade (CGPA: 2.70)



Date : 5/9/23

CERTIFICATION

This is to certify that **Ms. Thanuja D (Reg.No. P01BG21C0002)** is a bonafide student of PG Centre-M. Com, Sarada Vilas College, studying in the final year M.Com of the academic year 2022-23. As a partial fulfilment of her final examination M.Com, she has prepared a project report on "**A STUDY ON HOUSING LOAN FINANCING OF DISTRICT CO-OPERATIVE BANK LTD., MANDYA**" under the guidance of Ms. Arpitha K, Assistant Professor, PG Centre-M. Com, Sarada Vilas College, Mysuru. I certify that, this project work is her original work and not presented to any other University / Institution for award of any Degree/Diploma.

Dean

Dean

Commerce and Busi, Admn.

Sarada Vilas College

Mysuru-570 004

Principal

M.Sc., M.Phil., Ph.D.

Principal

Sarada Vilas College,

Krishnamurthypuram, Mysuru

Project Report

On

“An Assessment of Brand awareness and Brand loyalty of Bata India limited, with special reference to customer of sanchi enterprises. Hunsur”.

Submitted by

Sindhu

(Reg, No. P01BG21C0040)

Internal Guide

Ms. Arpitha. K

Assistant Professor

Department of Commerce M.com

Sarada Vilas College, Mysore

External Guide

Mr. Girisha. N

Branch Manager of Bata

India ltd. Hunsur.

Submitted To

University of Mysore

In partial fulfilment of award of Post Graduate Degree in Commerce (M. Com)

Department of Commerce P. G Centre- M. Com

Sarada Vilas College, Mysore

2022-2023



SARADA VILAS EDUCATIONAL INSTITUTIONS (Regd.)

SARADA VILAS COLLEGE

Krishnamurthypuram, Mysore – 570 004 Karnataka

Affiliated to University of Mysore

Re accredited by NAAC with B+ grade (CGPA: 2.70)



Date : 05/09/2023

CERTIFICATION

This is to certify that **Ms. Sindhu (Reg.No P01BG21C0040)** is a bonafide student of PG Centre-M. Com, Sarada Vilas College, studying in the final year M.Com of the academic 2022-23. As a partial fulfilment of her final examination M.Com, she has prepared a project report on **“AN ASSESSMENT OF BRAND AWARENESS AND BRAND LOYALTY OF BATA INDIA LIMITED WITH SPECIAL REFERENCE TO CUSTOMER OF SANCHI ENTERPRISES, HUNSUR”** under the guidance of Ms. Arpitha K, Assistant Professor, PG Centre-M. Com, Sarada Vilas College, Mysuru. I certify that, this project work is her original work and not presented to any other University / Institution for award of any Degree/Diploma.

Dean

Dean
Commerce and Busi. Admn.
Sarada Vilas Col.
Mysuru-570 004

Principal
M.Sc, M.Phil, Ph.D.
Principal
Sarada Vilas College
Krishnamurthypuram, Mysore

Bata

CERTIFICATE

This is to certify that **Ms. Sindhu (Reg No P01BG21C0040)** IV semester M.Com student of Sarada Vilas College, PG Centre, University of Mysore has undergone the project work on Assessment of brand awareness and brand loyalty of BATA India Ltd with special reference to customer of Saanchi enterprises Hunsur., She has completed her project from 15/06/2023 to 21/07/2023 on " on Assessment of brand awareness and brand loyalty of BATA India Ltd with special reference to customer of Saanchi enterprises Hunsur ". successfully under the guidance of Mr. Girisha.N, Branch Manager of BATA Saanchi enterprises, Hunsur. We wish her all the success in her future Endeavour.

Place: Hunsur

Date: 22/07/2023

with Regards



SAANCHI ENTERPRISES
#1702130001
Hunsur
BATA

Project Report

On

**“A Study on Customer preference toward the Professional Courier services
with reference to Mysuru city”**

Submitted by

Poornima G J

Reg. No: P01BG21C0052

Internal Guide

Ms. Arpitha K

Assistant Professor

Department of Commerce

PG Centre –M.Com

Sarada Vilas College, Mysuru

External Guide

Mr Uday Shankar.N.

Branch Manager

Submitted to

University of Mysore

In partial fulfilment of award of Post Graduate Degree in Commerce (M.Com)

Department of Commerce PG Centre – M.Com

Sarada Vilas College, Mysuru.

SARADA VILAS EDUCATIONAL INSTITUTIONS (Regd.)

SARADA VILAS COLLEGE

Krishnamurthypuram, Mysore – 570 004 Karnataka

Affiliated to University of Mysore

Re accredited by NAAC with B+ grade (CGPA: 2.70)



Date : 05/09/2023

CERTIFICATION

This is to certify that **Ms. Poornima G J (Reg.No P01BG21C0052)** is a bonafide student of PG Centre-M. Com, Sarada Vilas College, studying in the final year M.Com of the academic 2022-23. As a partial fulfilment of her final examination M.Com, she has prepared a project report on **“A STUDY ON CUSTOMER PREFERENCE TOWARD THE PROFESSIONAL COURIER SERVICES WITH REFERENCE TO MYSURU CITY”** under the guidance of Ms. Arpitha K, Assistant Professor, PG Centre-M. Com, Sarada Vilas College, Mysuru. I certify that, this project work is her original work and not presented to any other University / Institution for award of any Degree/Diploma.

Dean

Dean
Commerce and Busi, Admn.
Sarada Vilas College
Mysuru-570 004

Principal

Dr. M Devika
M.Sc., M.Phil., Ph.D.
Principal
Sarada Vilas College,
Krishnamurthypuram, Mysuru

CERTIFICATE

This is to certify that Ms. POORNIMA G J (Reg.No P01BG21C0052) 4th semester M.Com Student of Sarada Vilas College, PG centre, University of Mysuru has undergone the project work on

“A STUDY ON CUSTOMER PREFERENCE TOWARD THE PROFESSIONAL COURIER SERVICES WITH REFERENCE TO MYSURU CITY”

She has successfully completed her project in the academic year 2022-2023, under the guidance of Mr.Uday Shankar N, Branch manager. We wish her the entire success future Endeavour.

Date:

Place: MYSURU

With Regards

Uday Shankar N

Project report

"A Study On Compensation Management Linked With Performance
Appraisal Of Employees In PVR Cinemas In Mysuru"

Submitted by,

RAMYA HL

Reg No: P01BG21C0035

Internal guide

Miss Arpitha

Assistant professor

Department of commerce

Sarada vilas college , Mysuru

External guide

MR Arjun

Business HR

PVR Cinemas

Mysuru

Submitted To,

University of Mysuru

In partial fulfilment of award of post Graduate Degree in Commerce (m.com)

Department of commerce P.G Centre – M.COM

Sarada Vilas college



SARADA VILAS EDUCATIONAL INSTITUTIONS (Regd.)

SARADA VILAS COLLEGE

Krishnamurthypuram, Mysore – 570 004 Karnataka

Affiliated to University of Mysore

Re accredited by NAAC with B+ grade (CGPA: 2.70)



Date :

CERTIFICATION

This is to certify that **Ms Ramya H L (Reg.No. P01BG21C0035)** is a bonafide student of PG Centre-M. Com, Sarada Vilas College, studying in the final year M.Com of the academic 2022-23. As a partial fulfilment of her final examination M.Com, she has prepared a project report on **"A STUDY ON COMPENSATION MANAGEMENT LINKED WITH PERFORMANCE APPRAISAL OF EMPLOYEES IN PVR CINEMAS IN MYSURU"** under the guidance of Ms. Arpitha K, Assistant Professor, PG Centre-M. Com, Sarada Vilas College, Mysuru. I certify that, this project work is her original work and not presented to any other University / Institution for award of any Degree/Diploma.

Dean
Commerce and Busi, Admn,
Sarada Vilas College
Mysuru-570 004

Principal
Dr. M Devika
M.Sc., M.Phil., Ph.D.
Principal
Sarada Vilas College,
Krishnamurthypuram, Mysuru

Certificate

This is to certify that Ms. Ramya H L (Reg. No PBG21C0035) IV semester M COM Student of Sarada Vilas College, PG Centre, Mysore, affiliated to University of Mysore has undergone the project work on " A STUDY ON COMPENSATION MANAGEMENT LINKED WITH PERFORMANCE APPRAISAL OF EMPLOYEES IN PVR CINEMAS IN MYSURU"

She has successfully worked under my guidance.

We wish her all the success in her future endeavor.

For PVR Ltd



Business-HR

Place: Mysuru

Date:

PROJECT REPORT

**“A STUDY ON CONSUMER’S PREFERENCE ON ONLINE AND OFFLINE SHOPPING
OF SPECTACLES WITH SPECIAL REFERENCE TO LENSKART.COM”
CHAMUNDIPURAM, BRANCH MYSURU.**

Submitted by

HARSHITHA M.K

REG.NO: P01BG21C0036

Internal Guide

Miss. Arpitha. K
Assistant of professor
P.G Centre-M.com
Sarada Vilas College, Mysuru

External Guide

Arun Kumar. M
Manger of lenskart
Chamundipuram,
Mysuru

Submitted to

University of Mysuru

**In partial Fulfilment of award of post-Graduation Degree in Commerce (M. Com)
Department of commerce P. G Centre-M. Com
Sarada Vilas College, Mysuru.**



SARADA VILAS EDUCATIONAL INSTITUTIONS (Regd.)

SARADA VILAS COLLEGE

Krishnamurthypuram, Mysore – 570 004 Karnataka

Affiliated to University of Mysore

Re accredited by NAAC with B+ grade (CGPA: 2.70)



Date :

CERTIFICATION

This is to certify that **Ms Harshitha M K (Reg.No. P01BG21C0036)** is a bonafide student of PG Centre-M. Com, Sarada Vilas College, studying in the final year M.Com of the academic 2022-23. As a partial fulfilment of her final examination M.Com, she has prepared a project report on **"A STUDY ON CONSUMER'S PREFERENCE ON ONLINE AND OFFLINE SHOPPING OF SPECTACLES WITH SPECIAL REFERENCE TO LENSkart.COM" CHAMUNDIPURAM, BRANCH MYSURU** under the guidance of Ms. Arpitha K, Assistant Professor, PG Centre-M. Com, Sarada Vilas College, Mysuru. I certify that, this project work is her original work and not presented to any other University / Institution for award of any Degree/Diploma.

Dean

Dean
Commerce and Busi, Admn.
Sarada Vilas College
Mysuru-570 004

Principal

M.Sc., M.Phil., Ph.D.
Principal
Sarada Vilas College,
Krishnamurthypuram, Mysuru



Lenskart.com - New No 2954/4, Plot No K 12/4, Khata No 38/2004, Chamundipuram Circle
Mysuru, 570008.

CERTIFICATE

This is to certify that Ms. Harshitha M.K (reg, no P01BG21COO36) studying final year M.com in Sarada Vilas college, PG Centre, Mysuru, affiliated to University of Mysuru.

She has successfully completed her "**Project work**" on A Study on "consumer's preference on online and offline Shopping Spectacles of with special Reference to lenskart.com." Chamundipuram, Branch Mysuru.

We wish her all the success in her academic endeavor, and good luck with her next adventure.

Lenskart
New No. 2954/4, Plot No. K12/4,
Khata No. 38/2004
Chamundipuram Circle, Mysuru
Karnataka - 570008

Manager

Place: Mysuru

Project Report

**“ AFTER SALES SERVICES – ISSUES AND CHALLENGES
FACED BY PUNARVIKA ELECTRONICS HUNSUR”**

Submitted by

VINUTHA.P

Reg. No: P01BG21C0045

External Guide:

Mr. Devaker

Chief Operating Officer
Punarvika Electronics
Hunsur

Internal Guide:

Arpitha. K

Assistant Professor
Department of Commerce
P. G Centre- M. Com
Sarada Vilas College,
Mysuru

Submitted to

University of Mysore

In partial fulfilment of award of Post Graduate Degree in Commerce (M. Com)

Department of Commerce P. G Centre- M. Com

Sarada Vilas College, Mysuru.



SARADA VILAS EDUCATIONAL INSTITUTIONS (Regd.)

SARADA VILAS COLLEGE

Krishnamurthypuram, Mysore – 570 004 Karnataka
Affiliated to University of Mysore
Re accredited by NAAC with B+ grade (CGPA: 2.70)



Date : 05/09/2023

CERTIFICATION

This is to certify that **Ms. Vinutha P (Reg.No P01BG21C0045)** is a bonafide student of PG Centre-M. Com, Sarada Vilas College, studying in the final year M.Com of the academic 2022-23. As a partial fulfilment of her final examination M.Com, she has prepared a project report on "**AFTER SALES SERVICES - ISSUES AND CHALLENGES FACED BY PUNARVIKA ELECTRONICS HUNSUR**" under the guidance of Ms. Arpitha K, Assistant Professor, PG Centre-M. Com, Sarada Vilas College, Mysuru. I certify that, this project work is her original work and not presented to any other University / Institution for award of any Degree/Diploma.

Dean
Dean **Commerce and Busi, Admn.**
Sarada Vilas College
Mysuru-570 004

Principal
Dr. Anand Kumar
M.Sc., M.Phil., Ph.D.
Principal
Sarada Vilas College,
Krishnamurthypuram, Mysuru



Punarvika Electronics #18, 1st Division, JLB Road, Near Manti circle Hunsur – 571105

CERTIFICATE

This is to certify Ms. Vinutha P, (reg no P01BG21C0045) studying final year M.com in Sarada Vilas College, PG Centre, Mysuru, affiliated to University of Mysore.

She has successfully completed her “**Project Work**” on After sales service- issues and challenges faced by punarvika electronics Hunsur”.

We wish her all the very best for her future endeavor.

Manager

Place: Hunsur.

PUNARVIKA ELECTRO
No. 18 1st Division, JLB Road
JLB Road, Hunsur Town,
Mysuru District - 571105

Project Report

**"ROLE OF EVENT MANAGEMENT COMPANY IN PRESENT SCENARIO WITH
SPECIAL REFERENCE TO ROCKET EVENT"**

Submitted by

Nishanka P M

Reg. No: P01BG21C0003

Internal guide

Miss Arpitha

Assistant professor

Department of commerce

P.G Center- M.Com

Sarada vilas college, Mysuru

External guide

Mr Ajay kiran

Manager

For Event Management

Mysuru

Submitted To

University of Mysuru

In Partial Fulfilment of Aware of Post Graduate Degree In Commerce (M. Com)

Department of Commerce P.G Centre – M.com

Sarada Vilas College, Mysuru



SARADA VILAS EDUCATIONAL INSTITUTIONS (Regd.)

SARADA VILAS COLLEGE

Krishnamurthypuram, Mysore – 570 004 Karnataka

Affiliated to University of Mysore

Re accredited by NAAC with B+ grade (CGPA: 2.70)



Date : 5/9/23

CERTIFICATION

This is to certify that **Ms. Nishanka P M (Reg.No. P01BG21C0003)** is a bonafide student of PG Centre-M. Com, Sarada Vilas College, studying in the final year M.Com of the academic year 2022-23. As a partial fulfilment of her final examination M.Com, she has prepared a project report on **“ROLE OF EVENT MANAGEMENT COMPANIES IN THE PRESENT SCENARIO WITH SPECIAL REFERENCE TO ROCKET EVENTS, MYSURU”** under the guidance of Ms. Arpitha K, Assistant Professor, PG Centre-M. Com, Sarada Vilas College, Mysuru. I certify that, this project work is her original work and not presented to any other University / Institution for award of any Degree/Diploma.

Dean

Dean
Commerce and Busi. Admn.
Sarada Vilas College
Mysuru-570 004

Principal
Dr. M Devika
M.Sc., M.Phil., Ph.D.
Principal
Sarada Vilas College,
Krishnamurthypuram, Mysuru



Rocket events
Event Management Services

Certificate

This is to Certify that Ms Nishanka P M (reg no. P01BG21C0003) IV Semester M Com student of Sharada Vilas College, PG Centre, Mysore, Affiliated to University of Mysore has undergone the project work on

“ROLE OF EVENT MANAGEMENT IN PRESENT SITUATION WITH SPECIAL REFERENCE TO ROCKET EVENTS”

She has successfully worked under my guidance.

We wish her all the success in her future endeavours.

Place : Mysuru

Date : 02-08-2023

For ROCKET EVENTS

Proprietor

No 1648, C.P.C Building, Devaraja Mohalla, Gandhi Square -570001. Office:0821-4006421, 09986148811.
www.rocketevents.in GSTIN : 29CLYPP0600E1ZX

Project report

**TO STUDY THE DEMAND FOR AGRICULTURE MACHINERY WITH
SPECIAL REFERENCE TO BHAVANI INDUSTRIES**

Submitted by

AVIN

REG NO: P01BG21C0020

EXTERNAL GUIDE

Ms Arpitha.K

Assistant Professor

Department of commerce

P.G centre-M.com

INTERNAL GUIDE

SUNIL M D

Bhavani industries

Srirangapatna Mandya

Submitted to

University of Mysuru

In partial fulfilment of award of post graduate degree in commerce (M. Com)

Department of commerce P. G Centre- M. Com

Sarada Vilas College, Mysuru



SARADA VILAS EDUCATIONAL INSTITUTIONS (Regd.)

SARADA VILAS COLLEGE

Krishnamurthypuram, Mysore – 570 004 Karnataka

Affiliated to University of Mysore

Re accredited by NAAC with B+ grade (CGPA: 2.70)



Date : 05/09/2023

CERTIFICATION

This is to certify that **Mr. Avin (Reg.No. P01BG21C0020)** is a bonafide student of PG Centre-M. Com, Sarada Vilas College, studying in the final year M.Com of the academic year 2022-23. As a partial fulfilment of her final examination M.Com, he has prepared a project report on **“TO STUDY THE DEMAND FOR AGRICULTURAL MACHINERIES WITH SPECIAL REFERENCE TO BHAVANI INDUSTRIES, SRIRANGAPATNA, MANDYA”** under the guidance of Ms. Arpitha K, Assistant Professor, PG Centre-M. Com, Sarada Vilas College, Mysuru. I certify that, this project work is her original work and not presented to any other University / Institution for award of any Degree/Diploma.

Dean

Dean

Commerce and Busi, Admn.
Sarada Vilas College
Mysuru-570 004

Principal

Dr. M Devika

M.Sc., M.Phil., Ph.D.

Principal

Sarada Vilas College,
Krishnamurthypuram, Mysuru



BHAVANI INDUSTRIES

Gumbaz Road, GANJAM (P.O.) - 571 477, Srirangapatna Taluk, Mandya Dist. Karnataka State (India) ☎ : 08236-297073, Mob:9448189228, Email : bhavaniind9@gmail.com

CERTIFICATE

This is to certify that Mr. Avin (Reg No PO1BG21C0020) IV Semester M Com Student of Sharada Vilas College , PG center ,Mysore affiliated to University of Mysore has undergone the project work on

“To Study the demand for Agricultural Machineries with Special reference To Bhavani Industries, Srirangapatna, Mandya”

He has successfully worked under my guidance.

We wish him all the success in his future endeavor

Place: Srirangapatna

Date: 01/08/2023

For BHAVANI INDUSTRIES

For Bhavani Industries

Propnetor

PROJECT REPORT

**“A STUDY ON EMPLOYEE JOB SATISFACTIONS TOWARDS
MICROTECH SOLUTIONS’ IN MYSORE”**

Submitted by

VINITHA.K. D

REG.NO: P01BG21C0024

Internal Guide

Ms. Pragathi. K
Assistant of professor
P.G Centre-M.com
Sarada Vilas College, Mysore

External Guide

Mr. Ganesh Bhat
The proprietor
Microtech Solutions
Mysore

Submitted to

University of Mysuru

In partial Fulfilment of award of post-Graduation Degree in Commerce (M. Com)

Department of commerce P. G Centre-M. Com

Sarada Vilas College, Mysuru.



SARADA VILAS EDUCATIONAL INSTITUTIONS (Regd.)

SARADA VILAS COLLEGE

Krishnamurthypuram, Mysore – 570 004 Karnataka

Affiliated to University of Mysore

Re accredited by NAAC with B+ grade (CGPA: 2.70)



Date :

CERTIFICATION

This is to certify that Ms. Vinitha K D (Reg. No. P01BG21C0024) is a bonafide student of PG Centre-M.Com, Sarada Vilas College, studying M.Com final year in the academic year 2022-2023. As a part of her final examination M.Com she has prepared a project report " A Study on Employees job satisfaction towards Microtech Solution in Mysuru" under the guidance of Mrs Pragathi.K Assistant Professor, PG Centre-M.Com, Sarada Vilas College, Mysuru. I certify that, this project work is her original work and not presented to any other University / Institution for award of any Degree/Diploma.

Dean
Commerce and Busi, Admn.,
Sarada Vilas College
Mysuru-570 004

Principal
Dr. M Devika
M.Sc., M.Phil., Ph.D.
Principal
Sarada Vilas College,
Krishnamurthypuram, Mysuru

Certificate

This is to Certify that Ms.Vinitha.K.D.(reg.no P01BG21C0024) IV semester M Com Student of Sharada Vilas College, PG Centre, Mysore, affiliated to university of Mysore has undergone the project work on.

"A study on Employee Job satisfaction Towards Microtech Solutions in Mysore"

She has successfully worked under my guidance.

We wish her all the success in her future endeavor.

For Microtech Solutions

Proprietor

For Microtech solutions

Proprietor

Place: Mysore

Date:02.08.2023

Project report

**"A STUDY ON EMPLOYEE ABSENTEEISEMS CAUSES AND EFFECTS WITH
REFERENCE TO THE MYSORE PAINTS AND VARNISH LIMITED "**

Submitted by

SURYA.V

Reg No: P01BG21C0026

Internal Guide

Ms. Arpitha

Assistant professor

Department of commerce
P. G Centre-M. Com

Sarada Vilas College, Mysuru

External Guide

Raju

manager,

Mysuru paints and varnish ltd

Submitted to

University of Mysuru

In partial fulfilment of award of post graduate degree in commerce (M. Com)

Department of commerce P. G Centre- M. Com

Sarada Vilas college, Mysuru



SARADA VILAS EDUCATIONAL INSTITUTIONS (Regd.)

SARADA VILAS COLLEGE

Krishnamurthypuram, Mysore – 570 004 Karnataka

Affiliated to University of Mysore

Re accredited by NAAC with B+ grade (CGPA: 2.70)



Date : 05/09/2023

CERTIFICATION

This is to certify that Mr Surya V (Reg.No. P01BG21C0026) is a bonafide student of PG Centre-M. Com, Sarada Vilas College, studying in the final year M.Com of the academic 2022-23. As a partial fulfilment of her final examination M.Com, he has prepared a project report on **“EMPLOYEES ABSENTEEISM - CAUSES AND EFFECTS WITH REFERENCE TO MYSORE PAINTS AND VARNISH LIMITED, MYSURU”** under the guidance of Ms. Arpitha K, Assistant Professor, PG Centre-M. Com, Sarada Vilas College, Mysuru. I certify that, this project work is her original work and not presented to any other University / Institution for award of any Degree/Diploma.

Dean

Dean

Commerce and Busi, Admn.

Sarada Vilas College

Mysuru-570 004

Principal

Dr. M Devika

M.Sc., M.Phil., Ph.D.

Principal

Sarada Vilas College,
Krishnamurthypuram, Mysuru

ಮೈಸೂರು ಪೇಂಟ್ಸ್ & ವಾರ್ನಿಷ್ ಅಮಿಟೆಡ್

(ಕರ್ನಾಟಕ ಸರ್ಕಾರದ ಅಧೀನ ಉದ್ಯಮ)

MYSORE PAINTS & VARNISH LIMITED

(A Govt. of Karnataka Undertaking)



Paints With Royal Legacy
SINCE 1937

ISO 9001/2015 and ISO-14001/2015 CERTIFIED COMPANY



New Bannimantap Extension, Mysuru - 570015, Karnataka, India.

Ref: MPVL/Admin/2023-24/ 12

Date: 14.08.2023

CERTIFICATE

This is to certify that Mr Surya V, Reg No: P01BG21C0026, M.Com Student of Sarada Vilas College, Mysuru has carried out his "Project" at M/s. Mysore Paints and Varnish Ltd., Mysore, under the title "Employee Absenteeism Causes and Effect" under the guidance of Asst. Manager (HRD) of the Company.

We wish him all success in his future endeavour.

For Mysore Paints and Varnish Ltd.,

General Manager (Admin)

To:

M. Surya V,
Reg No: P01BG21C0026,
Sarada Vilas College,
MYSURU

Project Report

**“A STUDY ON CUSTOMER ACQUISITION STRATEGY ADOPTED
BY HYUNDAI MOTORS PVT LTD WITH SPECIAL REFERENCE TO
THE ADVAITH HYUNDAI, MYSURU”**

Submitted by

ARPITHA D

Reg. No: P01BG21C0044

Internal Guide

Ms. ARPITHA K
Assistant professor
P. G Centre – M.Com
Sarada Vilas College, Mysuru

External Guide

Mr. PRAMOD K C
Sales General Manager
Advaith Hyundai
Mysuru

Submitted To

University of Mysore

In partial fulfilment of award of Post Graduate Degree in Commerce (M.Com)

Department of commerce P.G Centre M.Com

Sarada Vilas College, Mysuru



SARADA VILAS EDUCATIONAL INSTITUTIONS (Regd.)

SARADA VILAS COLLEGE

Krishnamurthypuram, Mysore – 570 004 Karnataka

Affiliated to University of Mysore

Re accredited by NAAC with B+ grade (CGPA: 2.70)



Date : 05 - 09 - 2023

CERTIFICATION

This is to certify that **Ms. Arpitha D (Reg.No P01BG21C0044)** is a bonafide student of PG Centre-M. Com, Sarada Vilas College, studying in the final year M.Com of the academic 2022-23. As a partial fulfilment of her final examination M.Com, she has prepared a project report **“A STUDY ON CUSTOMER ACQUISITION STRATEGY ADOPTED BY HYUNDAI MOTORS PVT LTD WITH SPECIAL REFERENCE TO THE ADVAITH HYUNDAI, MYSURU”** under the guidance of Ms. Arpitha K, Assistant Professor, PG Centre-M. Com, Sarada Vilas College, Mysuru. I certify that, this project work is her original work and not presented to any other University / Institution for award of any Degree/Diploma.

Dean

Dean

Commerce and Busi, Admn.
Sarada Vilas College
Mysuru-570 004

Principal

M.Sc., M.PHIL., Ph.D.

Principal

Sarada Vilas College,
Krishnamurthypuram, Mysuru



ADVAITH MOTORS PVT. LTD

Plot No. 26/A/B/C, Sy No 51, Belwadi Indl. Area, Kasba Hobli, Mysore - 18
Ph : 0821 - 4261901/02/03/04 fax : 0821 - 4261905

AUTHORISED DEALERS FOR HYUNDAI MOTORS INDIA LTD.

Certificate

This is to certify that Ms.Arpitha.D (Reg.No - P01BG21C0044) IV semester M.Com Student of Sarada Vilas College, PG Center, Mysuru, affiliated to University of Mysuru has undergone the project work on

“A Study on Customer Acquisition Strategy Adopted by Hyundai Motors Pvt Ltd with special Reference to the Advaith Hyundai, Mysuru”.

She has successfully worked under my guidance.

We wish her all success in her future endeavor.

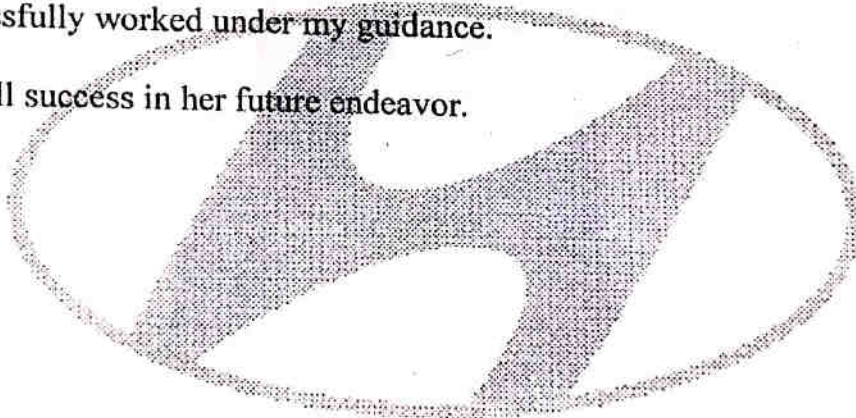

For Advaith Motor's Pvt ltd.,



The General Manager (Sales)
Advith Motor's Pvt Ltd
Place : Mysore Belwadi
Date : 01.08.2023

ADVAITH MOTORS PVT. LTD
HYUNDAI
Plot No. 26/A/B/C, Sy. No.51,
Belwadi Indl. Area, Kasaba Hobli,
Mysore-570 018
Tel: 0821-2409901 / 82 / 83

Project Report

**“A STUDY OF AN INVESTOR PREFERENCE TOWARDS EQUITY AND
MUTUAL FUND WITH SPECIAL REFERENCE TO THE CHOICE
EQUITY BROKING PRIVATE LIMITED, MYSURU.”**

Submitted by

SANJITHA.M

Reg. No: P01BG21C0031

Internal Guide

Ms. Arpitha K

Assistant Professor

Department of Commerce

P. G Centre- M. Com

Sarada Vilas College, Mysuru

External Guide

Mr. Chandrashekar Murthy

Sales Manager

Choice Equity Broking Pvt Ltd

Mysuru

Submitted To

University of Mysuru

In partial fulfillment of award of Post Graduate Degree in Commerce (M. Com)

Department of Commerce P.G Centre-M.com

Sarada Vilas College, Mysuru.



SARADA VILAS EDUCATIONAL INSTITUTIONS (Regd.)

SARADA VILAS COLLEGE

Krishnamurthypuram, Mysore – 570 004 Karnataka

Affiliated to University of Mysore

Re accredited by NAAC with B+ grade (CGPA: 2.70)



Date :05-09-2023

CERTIFICATION

This is to certify that **Ms Sanjitha M (Reg.No. P01BG21C0031)** is a bonafide student of PG Centre-M. Com, Sarada Vilas College, studying in the final year M.Com of the academic 2022-23. As a partial fulfilment of her final examination M.Com, she has prepared a project on **“A STUDY OF AN INVESTOR PREFERENCE TOWARDS EQUITY AND MUTUAL FUND WITH SPECIAL REFERENCE TO THE CHOICE EQUITY BROKING PRIVATE LIMITED, MYSURU”** under the guidance of Ms. Arpitha K, Assistant Professor, PG Centre-M. Com, Sarada Vilas College, Mysuru. I certify that, this project work is her original work and not presented to any other University / Institution for award of any Degree/Diploma.

Dean

Dean
Commerce and Busi, Admn.
Sarada Vilas College
Mysuru-570 004

Principal

Dr. M Devika

M.Sc., M.Phil., Ph.D.

Principal

Sarada Vilas College,
Krishnamurthypuram, Mysuru

CERTIFICATE

This is to certify that **Ms. Sanjitha M (reg. no PO1BG21C0031)** IV semester M.Com Student of Sarada Vilas College, PG Centre, Mysore, affiliated to University of Mysore has undergone the project work on

“A study of an investor preference towards equity and mutual fund with special reference to the Choice Equity Broking Pvt Ltd”

he has successfully worked under my guidance.

We wish her all the success in her future endeavor.

For choice equity broking private limited

Manager

Place: Mysuru

A
Project Report
On

**"A STUDY ON CUSTOMER SATISFACTION TOWARDS TVS MOTORS WITH
REFERENCE TO TVS MOTORS PANDAVARAPURA"**

Submitted by

SAHANA S

Reg. No: P01BG21C0023

Internal Guide

Miss. Arpitha K

Assistant Professor

Department of Commerce

P. G Centre- M. Com

Sarada Vilas College, Mysuru

External Guide

Shobha . L

Chief Operating Officer

Shree Trinayani Motors (TVS)

Pandavapura

Submitted to

University of Mysore

In partial fulfilment of award of Post Graduate Degree in Commerce (M.Com)

Department of Commerce P. G Centre- M. Com

Sarada Vilas College, Mysuru

Phone: 0821-2332479, Fax: 0821-2330221

E- mail: principal@saradavilas.com

website: www.saradavilas.com

SARADA VILAS EDUCATIONAL INSTITUTIONS (Regd.)

SARADA VILAS COLLEGE

Krishnamurthypuram, Mysore – 570 004 Karnataka

Affiliated to University of Mysore

Re accredited by NAAC with B+ grade (CGPA: 2.70)



Date : 05/09/2023

CERTIFICATION

This is to certify that **Ms. Sahana S (Reg.No. P01BG21C0023)** is a bonafide student of PG Centre-M. Com, Sarada Vilas College, studying in the final year M.Com of the academic year 2022-23. As a partial fulfilment of her final examination M.Com, she has prepared a project report on **“A STUDY ON CUSTOMER SATISFACTION TOWARDS TVS MOTORS WITH REFERENCE TO TVS MOTORS PANDAVAPURA”** under the guidance of Ms. Arpitha K, Assistant Professor, PG Centre-M. Com, Sarada Vilas College, Mysuru. I certify that, this project work is her original work and not presented to any other University / Institution for award of any Degree/Diploma.

Dean

Dean
Commerce and Busi, Admn.
Sarada Vilas College
Mysuru-570 004

Principal

Dr. M Devika
M.Sc, M.Phil, Ph.D.
Principal
Sarada Vilas College,
Krishnamurthypuram, Mysuru



SREE TRRINAYANI TVS

Opp. Bannaramma Temple,
Pandavapura - 571 434

e-mail : sreetrrinayanitvs@gmail.com
Ph.: 8951165015 / 9481213468

Certificate

This is to certify that Ms. Sahana S [Reg. No P01BG21C0023] IV semester M.Com student of Sarada Vilas College, PG Center, Mysore has undergone the project work on " A study on customer satisfaction towards TVS motors with reference to TVS motors Pandavapura" . She has successfully worked under my guidance and we wish her all the success in her future endeavor.

For SREE TRRINAYANI MOTORS PANDAVAPURA



Sahana S. L.

Chief operating officer

Place: Pandavapura

Date: 01/08/2023

**A
Project Report**

on

**Analysis of the Financial Statement for Profitability Assessment of St. Milagres
Credit Souhardha Co-operative Limited., Karwar
Branch: - N.R. Mohalla**

Submitted by

DARSHAN

Reg. No: P01BG21C0028

Internal Guide

Ms. Arpitha K

Assistant Professor

Department of Commerce

P. G Centre- M. Com

Sarada Vilas College, Mysuru

External Guide

Mr. Ajay Arokya Raj

Manager

St. Milagres Credit

Souhardha Co-operative

LTD., N R Mohalla.

Mysuru

Submitted To

University of Mysuru

In partial fulfillment of award of Post Graduate Degree in Commerce (M. Com)

Department of Commerce P.G Centre-M.com

Sarada Vilas College, Mysuru.



SARADA VILAS EDUCATIONAL INSTITUTIONS (Regd.)

SARADA VILAS COLLEGE

Krishnamurthypuram, Mysore – 570 004 Karnataka

Affiliated to University of Mysore

Re accredited by NAAC with B+ grade (CGPA: 2.70)



Date : 05-09-2023

CERTIFICATION

This is to certify that **Mr Darshan (Reg.No. P01BG21C0028)** is a bonafide student of PG Centre-M. Com, Sarada Vilas College, studying in the final year M.Com of the academic 2022-23. As a partial fulfilment of her final examination M.Com, he has prepared a project report on **“AN ANALYSIS OF THE FINANCIAL STATEMENT FOR PROFITABILITY ASSESSMENT OF ST. MILAGRES CREDIT SOUHARDHA CO-OPERATIVE LTD., KARWAR”** under the guidance of Ms. Arpitha K, Assistant Professor, PG Centre-M. Com, Sarada Vilas College, Mysuru. I certify that, this project work is her original work and not presented to any other University / Institution for award of any Degree/Diploma.

Dean

Dean

Commerce and Busi, Admn.

Sarada Vilas College

Mysuru-570 004

Principal

Jr. M Devika

M.Sc., M.Phil., Ph.D.

Principal

Sarada Vilas College,

Krishnamurthypuram, Mysuru



ಸ್ರೋಂಟ್ ಮಿಲಾಗ್ರಿಸ್ ಕ್ರೆಡಿಟ್ ಸೌಹಾರ್ದ ಕೋ-ಆಪರೇಟಿವ್ ಲಿ., ಕಾರವಾರ
ST. MILAGRES CREDIT SOUHARDHA CO-OPERATIVE LIMITED, KARWAR
(Regd. No. DRN/RSR/1251/SOU.SA/08-09)

#155, "Jayajyothi" 6th Cross, Tank Road, Opp : Thibbadevi Theater., N. R. MOHALLA, MYSURU-570007
Cell : 9606013305

No. MSCC / 412

Date: 03/08/2023

CERTIFICATE

THIS IS TO CERTIFY THAT MR. DARSHAN (REG.NO. P01BG21C0028) 4TH SEMESTER M.COM STUDENT OF SARADA VILAS COLLAGE , PG CENTER, UNIVERSITY OF MYSURU HAS UNDERGONE THE PROJECT WORK ON PROFITABILITY ANALYSIS. HE HAS COMPLETED HIS PROJECT ON "ANALYSIS OF THE FINANCIAL STATEMENT FOR PROFITABILITY ASSESSMENT OF ST. MILAGRES CREDIT SOUHARDHA CO-OPERATIVE SOCIETY LIMITED., KARWAR". SUCCESSFULLY UNDER THE GUIDANCE OF MR. AJAY AROKYA RAJ, BRANCH MANAGER ST.MILAGRES CREDIT SOUHARDHA CO-OPERATIVE LTD, N R MOHALLA BRANCH, MYSURU. WE WISH HIM ALL THE SUCCESS IN HIS FUTURE ENDEAVOUR.

For ST. MILAGRES CREDIT SOU. CO-OP. SOCIETY LTD., KARWAR, BRANCH: N.R. MOHALLA, MYSURU

Ajay Aroky Raj
BRANCH MANAGER

WITH REGARDS

PLACE : N RMOHALLA, MYSURU

DATE : 03-08-2023

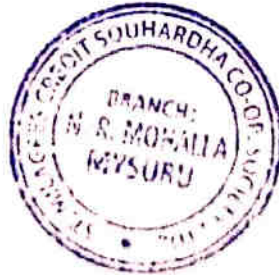

HEAD OFFICE

ಕೇಶವ ಶೆಟ್ಟ ರಸ್ತೆ, ಮೊದಲನೇ ಕ್ರಾಸ್, ಸೋನಾರವಾಡಾ, ಕಾರವಾರ - 581 304

Keshav Shet Road, 1st Cross, Sonarwada, Karwar - 581 304 ಫ : 08382- 223600, Cell: 9538883677